

Anti-lock brake system (ABS) with electronic differential lock (EDL), anti-slip regulation (ASR) and electronic stabilization program (ESP)

from January 2002

Deviate relay location and fuseplacements as well as the locations of multiple connectors see section "component locations".

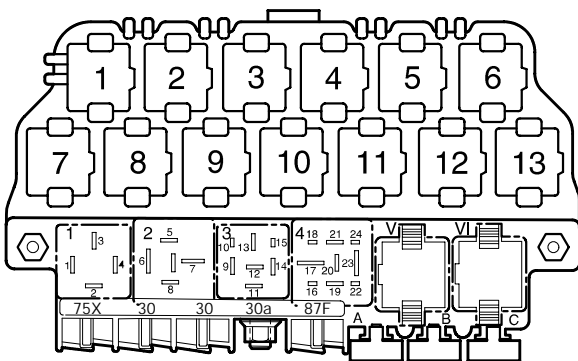

97-20676

Relay location on the thirteen position auxiliary relay panel, above relay panel:

Relay panel:

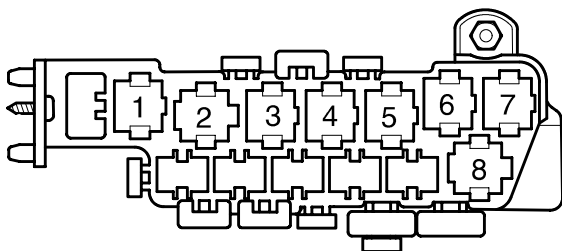

97-20515

Relay location on the eight position auxiliary relay panel, behind relay panel:

Note: Number in parentheses indicates production control number stamped on relay housing.

- Fuse colors
- 30 A - green
 - 25 A - white
 - 20 A - yellow
 - 15 A - blue
 - 10 A - red
 - 7,5 A - brown
 - 5 A - beige

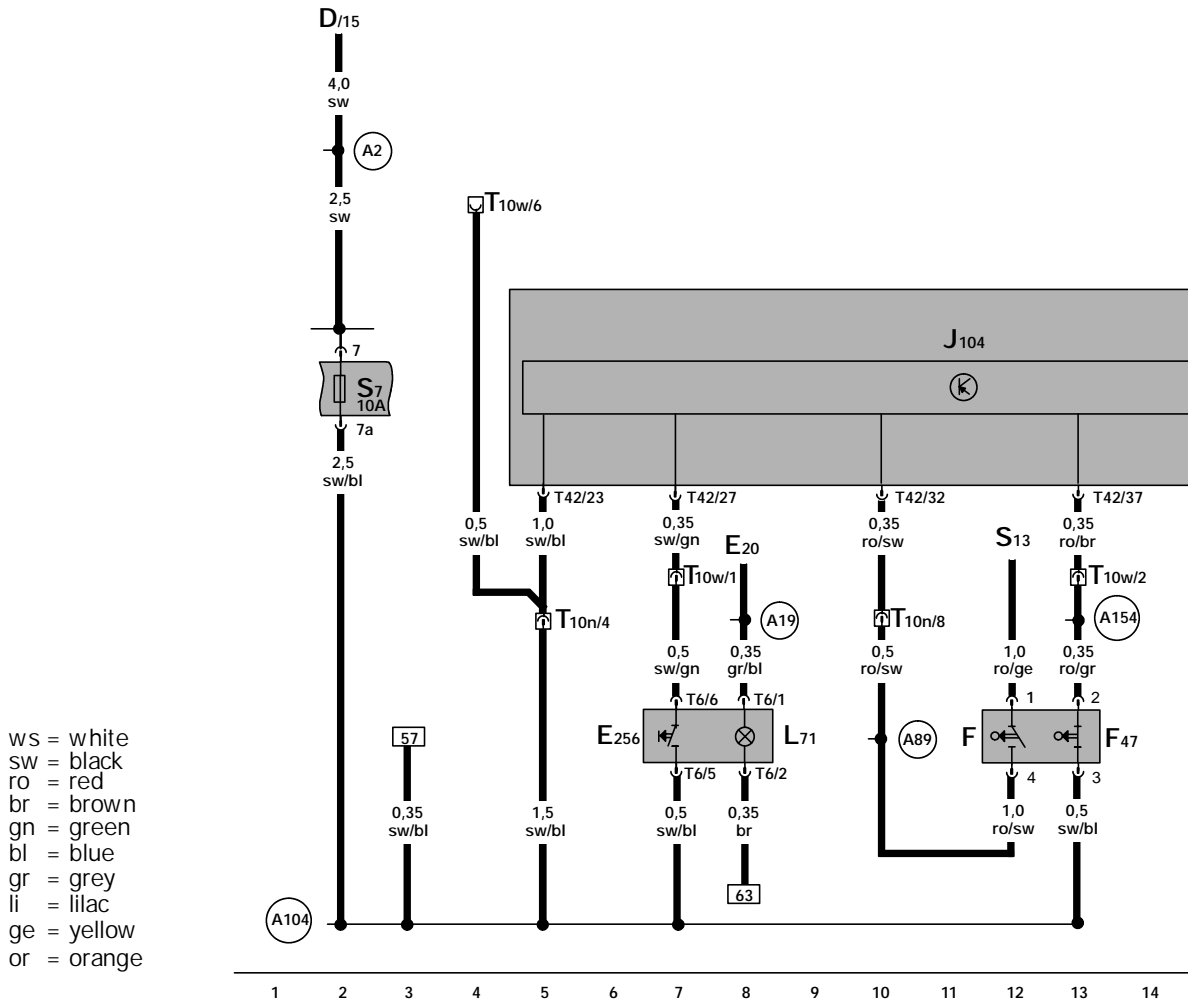

ws = white
 sw = black
 ro = red
 br = brown
 gn = green
 bl = blue
 gr = grey
 li = lilac
 ge = yellow
 or = orange

97-31447

- D - Ignition/Starter Switch
- E20 - Instrument Panel Light Dimmer Switch
- E256- ASR/ESP Button
- F - Brake Light Switch
- F47 - Brake Pedal Switch (cruise control/Diesel Direct Fuel Injection)
- J104 - ABS Control Module (w/EDL)
- L71 - Anti-slip Control Switch Illumination
- S7 - Fuse
- S13 - Fuse
- T6 - 6-Pin Connector, red, on ASR/ESP Button
- T10n - 10-Pin Connector, orange, connector station
 A-pillar, left
- T10w - 10-Pin Connector, grey, connector station
 A-pillar, right
- T42 - 42-Pin Connector, on ABS Control Module

- (A19) - wire connection (58d), in instrument panel wiring harness
- (A89) - Connection 2 (54) (in instrument panel wiring harness)
- (A104) - Plus connector -2- (15), in instrument panel wiring harness
- (A154) - Brake Pedal Switch Connection (in instrument panel wiring harness)

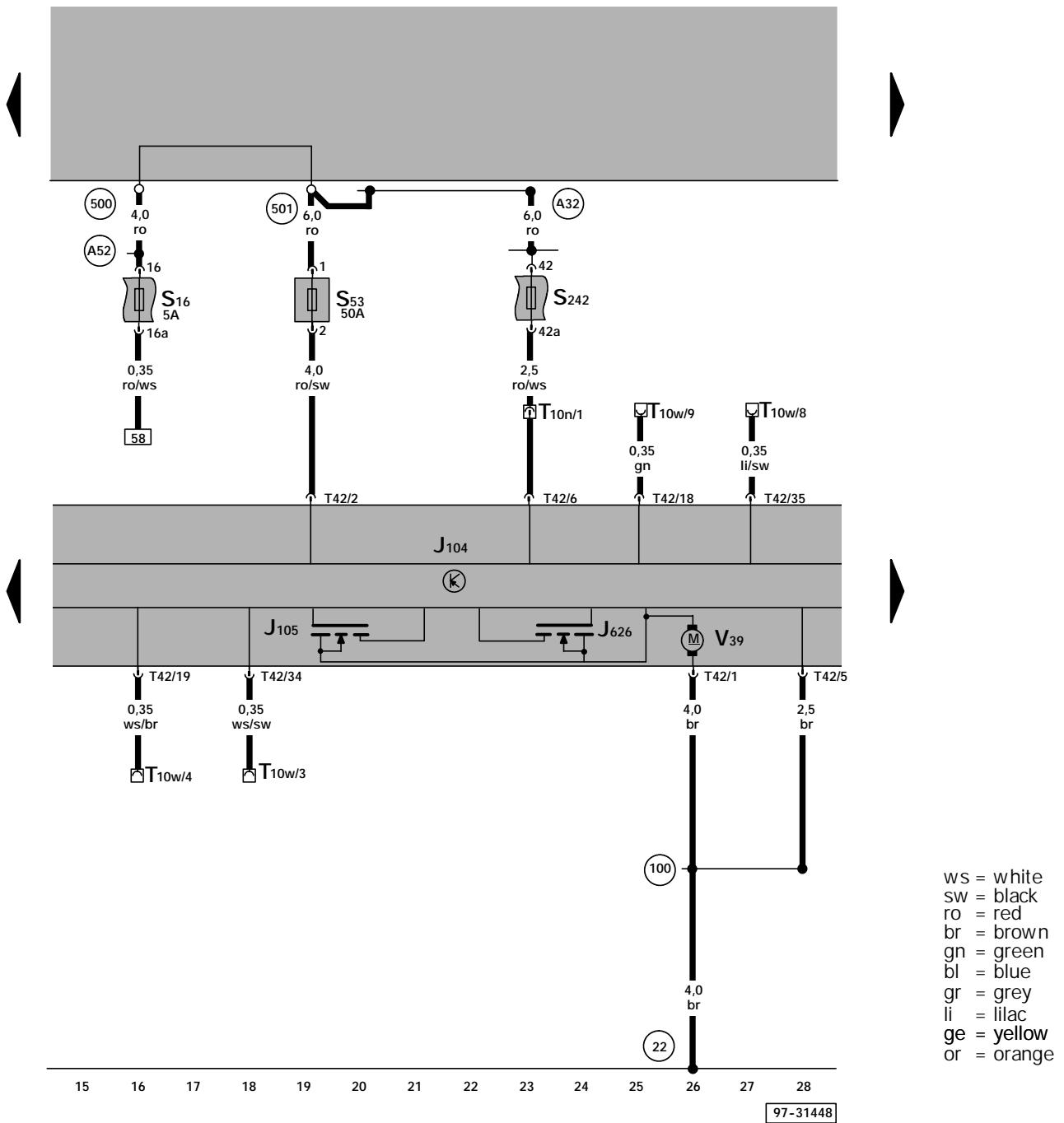

- J104 - ABS Control Module (w/EDL)
- J105 - ABS Return Flow Pump Relay
- J626 - ABS Return Flow Pump Relay 2
- S16 - Fuse
- S53 - ABS Hydraulic Pump Fuse
- S242 - Fuse in fuse holder
- T10n - 10-Pin Connector, orange, connector station A-pillar, left
- T10w - 10-Pin Connector, grey, connector station A-pillar, right
- T42 - 42-Pin Connector, on ABS Control Module
- V39 - ABS Return Flow Pump

- (22) - Ground connection, on hydraulic unit
- (100) - Ground connection -1-, in ABS wiring harness
- (500) - Threaded connection -1- (30) on the relay plate
- (501) - Threaded connection -2- (30) on the relay plate
- (A32) - plus connection (30), in instrument panel wiring harness
- (A52) - Plus Connection 2 (30) (in instrument panel wiring harness)

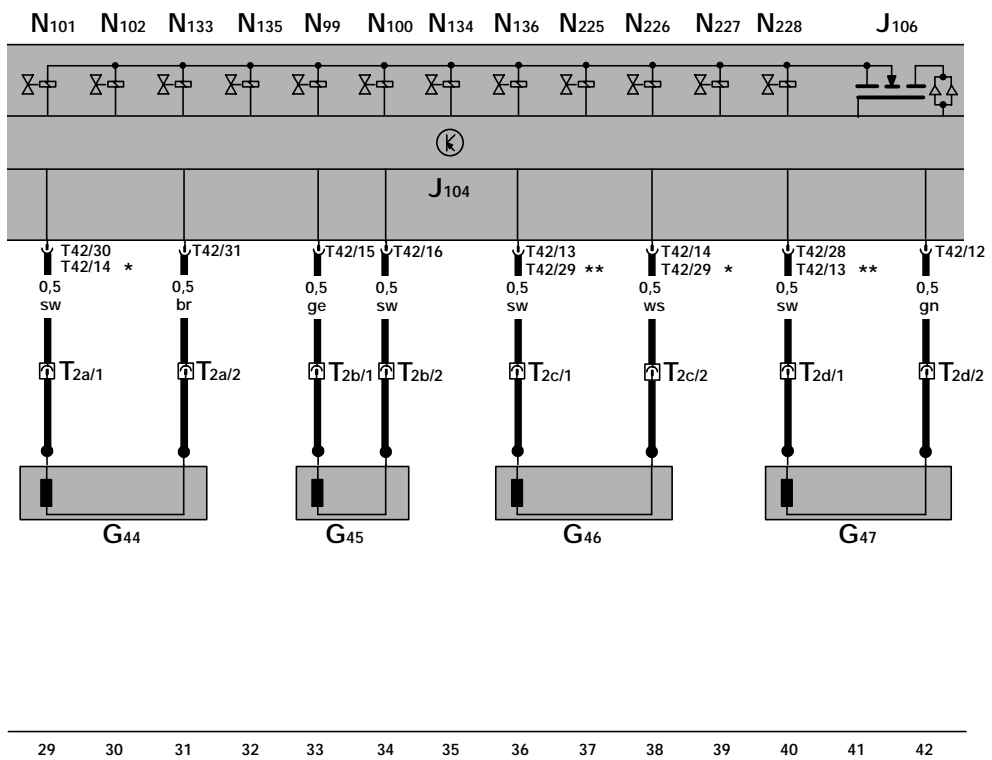

ws = white
 sw = black
 ro = red
 br = brown
 gn = green
 bl = blue
 gr = grey
 li = lilac
 ge = yellow
 or = orange

97-31449

- G44 - Right Rear ABS Wheel Speed Sensor
- G45 - Right Front ABS Wheel Speed Sensor
- G46 - Left Rear ABS Wheel Speed Sensor
- G47 - Left Front ABS Wheel Speed Sensor
- J104 - ABS Control Module (w/EDL)
- J106 - ABS Solenoid Valve Relay
- N99 - Right Front ABS Inlet Valve
- N100 - Right Front ABS Outlet Valve
- N101 - Left Front ABS Inlet Valve
- N102 - Left Front ABS Outlet Valve
- N133 - Right Rear ABS Inlet Valve
- N134 - Left Rear ABS Inlet Valve
- N135 - Right Rear ABS Outlet Valve
- N136 - Left Rear ABS Outlet Valve
- N225 - Pilot valve -1- traction control
- N226 - Pilot valve -2- traction control

- N227 - High pressure switch valve -1- traction control
- N228 - High pressure switch valve -2- traction control
- T2a - 2-Pin Connector
- T2b - 2-Pin Connector
- T2c - 2-Pin Connector
- T2d - 2-Pin connector
- T42 - 42-Pin Connector, on ABS Control Module
- * - 4 -motion only
- ** - code ATQ only

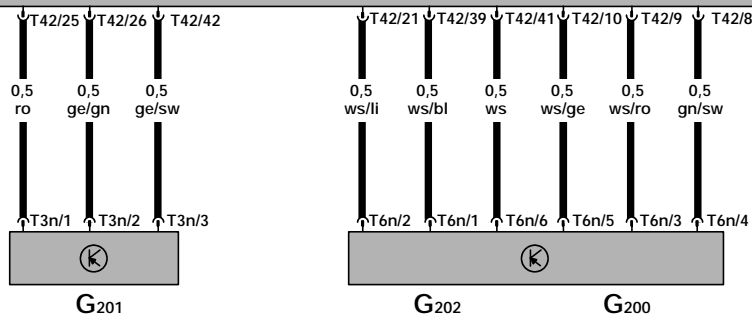
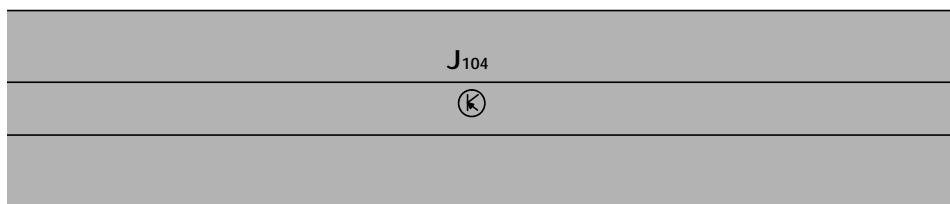

ws = white
 sw = black
 ro = red
 br = brown
 gn = green
 bl = blue
 gr = grey
 li = lilac
 ge = yellow
 or = orange

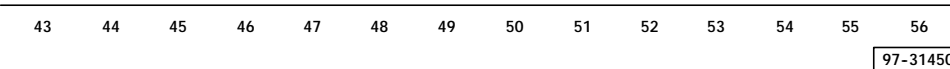

- G200- Sensor for transverse acceleration
- G201 - Sender 1 for brake booster
- G202- Sender for Rotation Rate
- J104 - ABS Control Module (w/EDL)
- T3n - 3-Pin Connector, on Sender for brake booster
- T6n - 6-Pin Connector, black
- T42 - 42-Pin Connector, on ABS Control Module



ws = white
 sw = black
 ro = red
 br = brown
 gn = green
 bl = blue
 gr = grey
 li = lilac
 ge = yellow
 or = orange

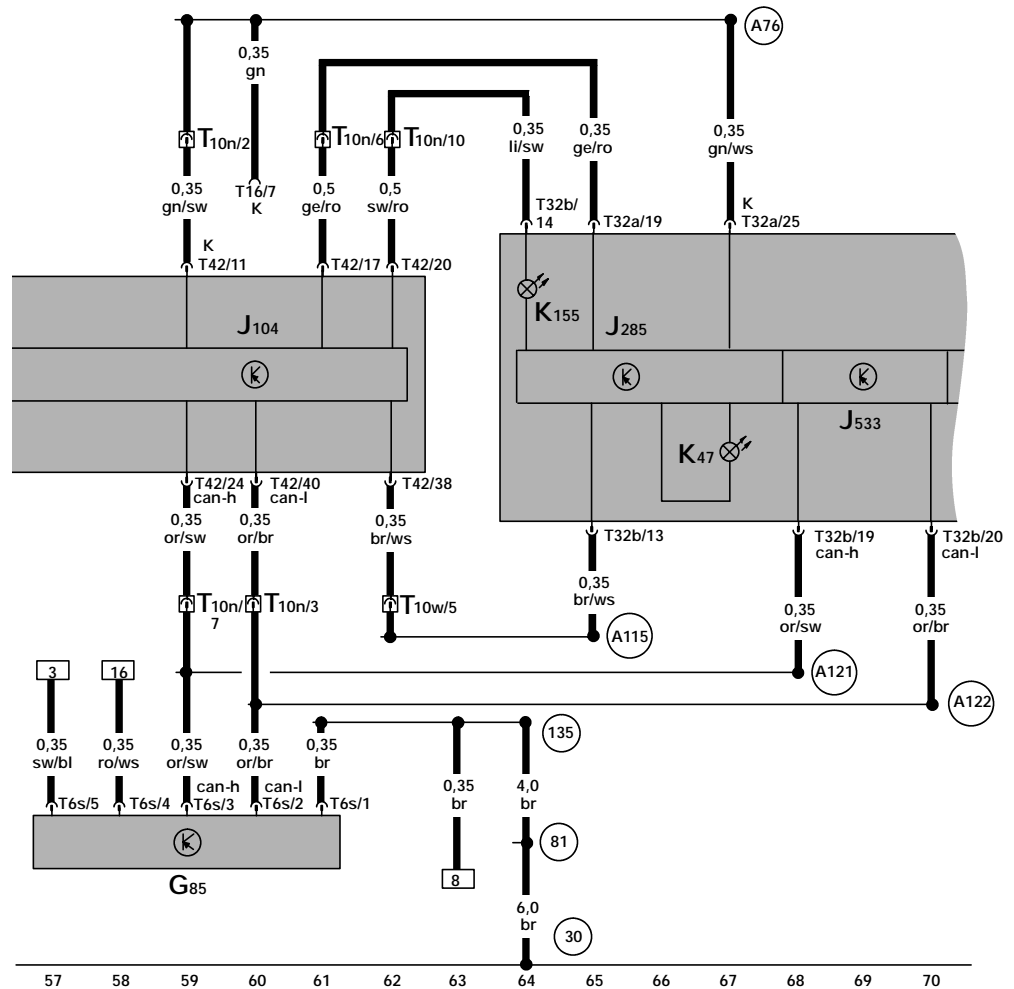

97-31451

- G85 - Steering Angle Sensor
- J104 - ABS Control Module (w/EDL)
- J285 - Control module with indicator unit in instrument panel insert
- J533 - Data Bus On Board Diagnostic Interface
- K47 - ABS Warning Light
- K155 - ASR/ESP Control Lamp
- T6s - 6-Pin connector, black
- T16 - 16-Pin connector, Data Link Connector (DLC), below instrument panel, left
- T10n - 10-Pin Connector, orange, connector station A-pillar, left
- T10w - 10-Pin Connector, grey, connector station A-pillar, right
- T32a - 32-Pin Connector, blue, on instrument cluster
- T32b - 32-Pin Connector, green, on instrument cluster
- T42 - 42-Pin Connector, on ABS Control Module

- (30) - Ground connection -1-, beside fuse/relay panel
- (81) - Ground connection -1-, in instrument panel wiring harness
- (135) - Ground connection -2-, in instrument panel wiring harness
- (A76) - Connector (K-diagnosis wire) in instrument panel wiring harness
- (A115) - Connection (parking brake control) in instrument panel wiring harness
- (A121) - Connection (high bus) in instrument panel wiring harness
- (A122) - Connection (low bus) in instrument panel wiring harness