

**1,8L- Engine - Motronic Multiport Fuel Injection (MFI)/110 kW, code AEB,**

from August 1998

Deviate relay location and fuseplacements as well as the locations of multiple connectors see section "component locations".

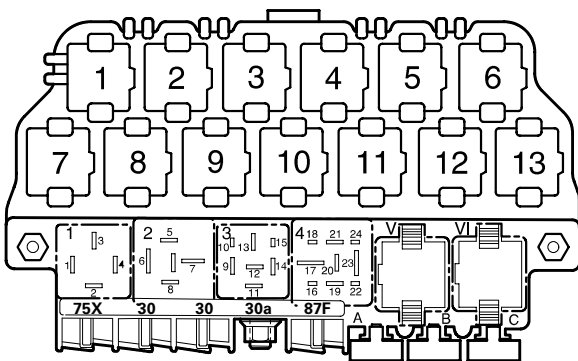

97-20676

Relay location on the thirteenfold auxiliary relay panel, above relay panel:

Relay panel:

- 4** Fuel Pump (FP) Relay (208)

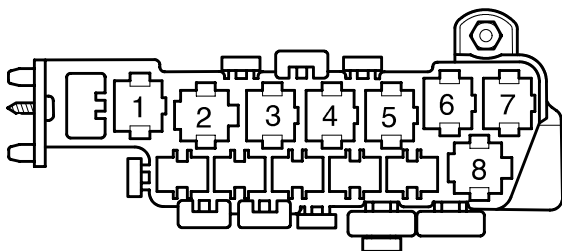

97-20515

Relay location on the eightfold auxiliary relay panel, behind relay panel:

**Fuse colors**

- 30 A - green
- 25 A - white
- 20 A - yellow
- 15 A - blue
- 10 A - red
- 7,5 A - brown
- 5 A - beige

Note: Number in parentheses indicates production control number stamped on relay housing.

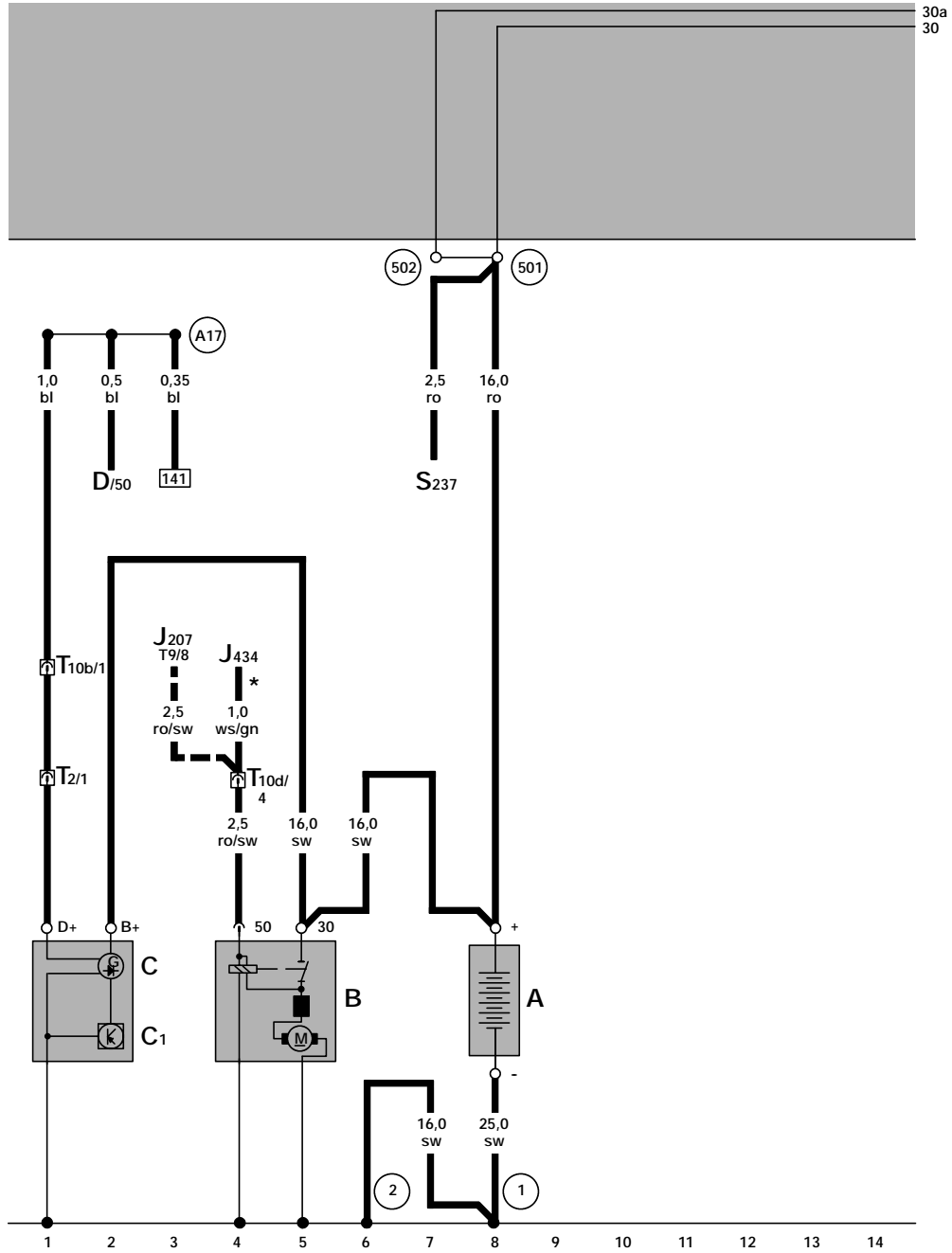

ws = white  
 sw = black  
 ro = red  
 br = brown  
 gn = green  
 bl = blue  
 gr = grey  
 li = violet  
 ge = yellow

- A - Battery
- B - Starter
- C - Generator (GEN)
- C1 - Voltage Regulator (VR)
- D - Ignition/Starter Switch
- J207 - Starting Interlock Relay
- J434 - Starting Interlock Realy (clutch position), manual transmission only
- S237 - Fuse 37 in fuse holder
- T2 - Double Connector, on engine right
- T9 - 9-Pin Connector, on Starting Interlock Relay
- T10b - 10-Pin Connector, black, on protective housing for control module, in engine compartment, left
- T10d - 10-Pin Connector, brown, on protective housing for control module, in engine compartment, left

- ① - Ground strap, battery to body
- ② - Ground strap, transmission to body
- ⑤01 - Screw Connection -2- (30), on relay panel
- ⑤02 - Screw Connection (30a), on relay panel
- ①7 - wire connection (61), in instrument panel wiring harness
- \* - manual transmission only
- - - automatic transmission only

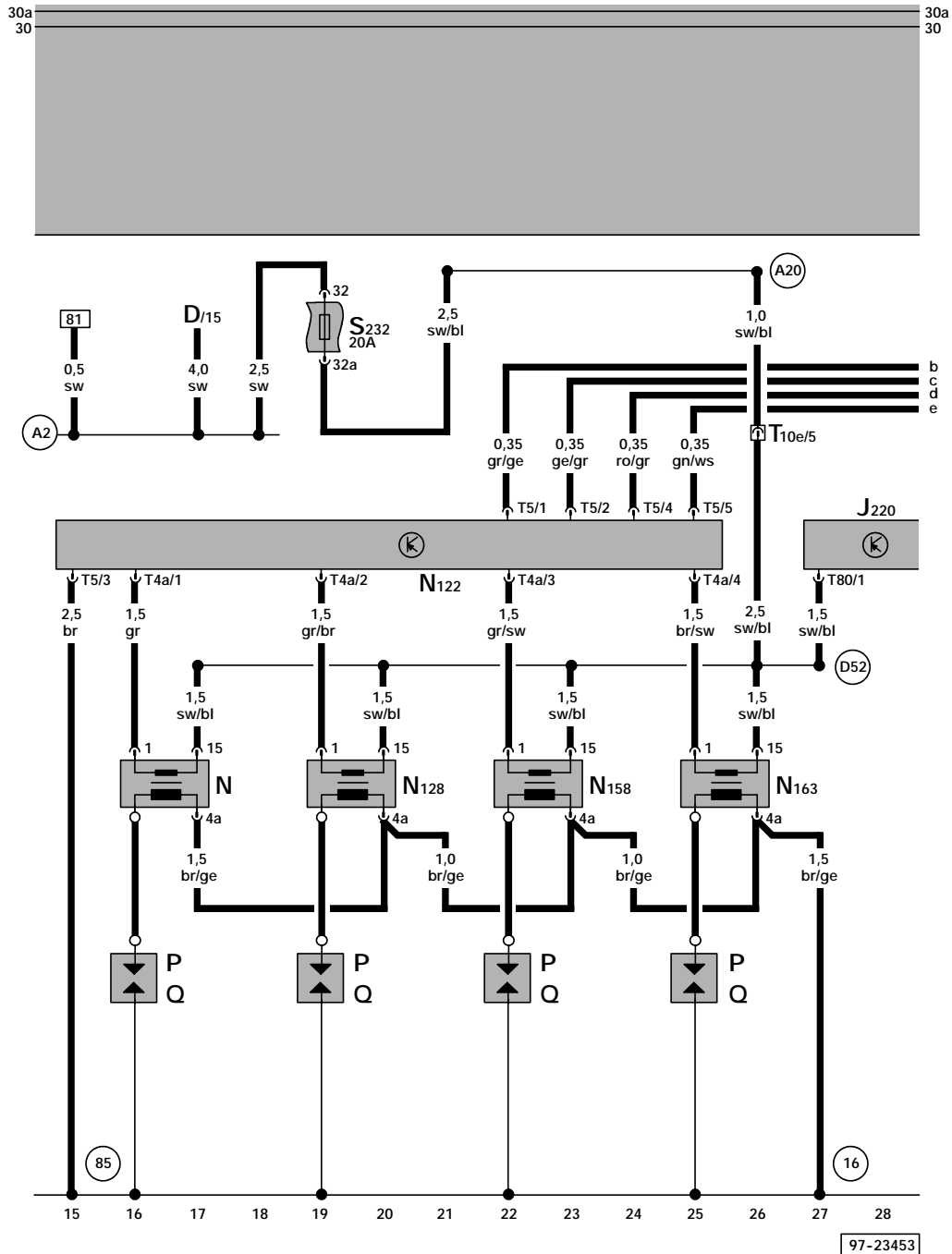

ws = white  
 sw = black  
 ro = red  
 br = brown  
 gn = green  
 bl = blue  
 gr = grey  
 li = violet  
 ge = yellow

- D - Ignition/Starter Switch
- J220 - Motronic Engine Control Module (ECM)
- N - Ignition Coil
- N122 - Power Output Stage
- N128 - Ignition Coil 2
- N158 - Ignition Coil 3
- N163 - Ignition Coil 4
- P - Spark Plug Connectors
- Q - Spark Plugs
- S231 - Fuse 31 in fuse holder
- S232 - Fuse 32 in fuse holder
- T4a - 4-Pin Connector, black, on power output stage
- T5 - 5-Pin Connector, black, on power output stage
- T10e - 10-Pin Connector, black, on protective housing for control module, in engine compartment, left
- T80 - Connector, 80 point, on Motronic Engine Control Module (ECM)

- (16) - Ground connection -1-, on valve cover
- (85) - Ground connection -1-, in engine compartment wiring harness
- (A2) - plus connection (15), in instrument panel wiring harness
- (A20) - wire connection (15a), in instrument panel wiring harness
- (D52) - plus connection (15a), in engine compartment wiring harness

97-23453

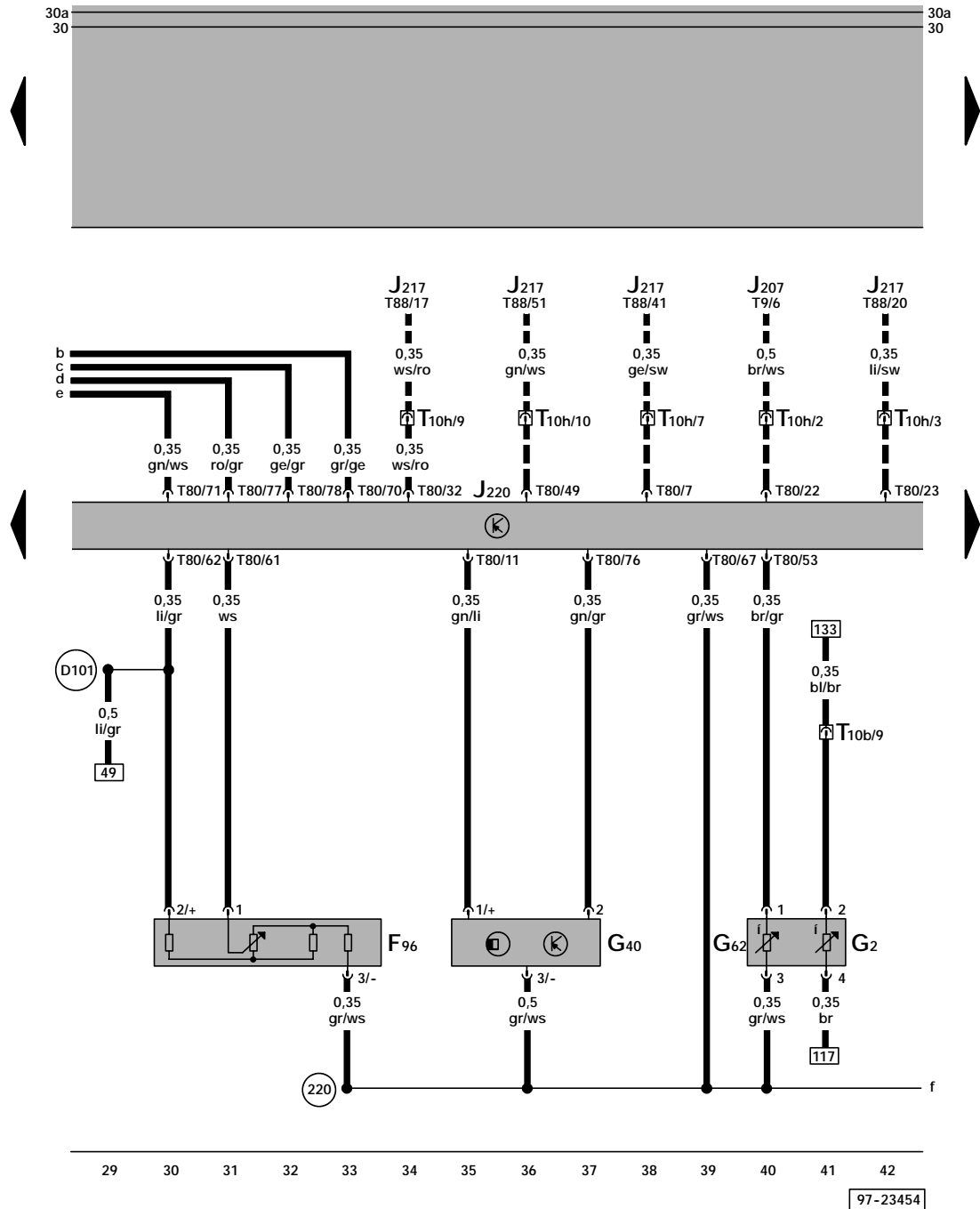

- F96 - Barometric Pressure (BARO) Sensor
- G2 - Engine Coolant Temperature (ECT) Sensor
- G40 - Camshaft Position (CMP) Sensor
- G62 - Engine Coolant Temperature (ECT) Sensor
- J207 - Starting Interlock Relay
- J217 - Transmission Control Module (TCM)
- J220 - Motronic Engine Control Module (ECM)
- T9 - 9-Pin Connector, on starting interlock relay
- T10b - 10-Pin Connector, black, on protective housing for control module, in engine compartment, left
- T10h - 10-Pin Connector, blue, on protective housing for control module, in engine compartment, left
- T80 - Connector, 80 point, on Motronic Engine Control Module (ECM)
- T88 - Connector, 88 point, on Transmission Control Module (TCM)

- (220) - Ground connection (sensor ground), in engine compartment wiring harness
- (D101) - Wire connection -1-, in engine compartment wiring harness
- - - automatic transmission only

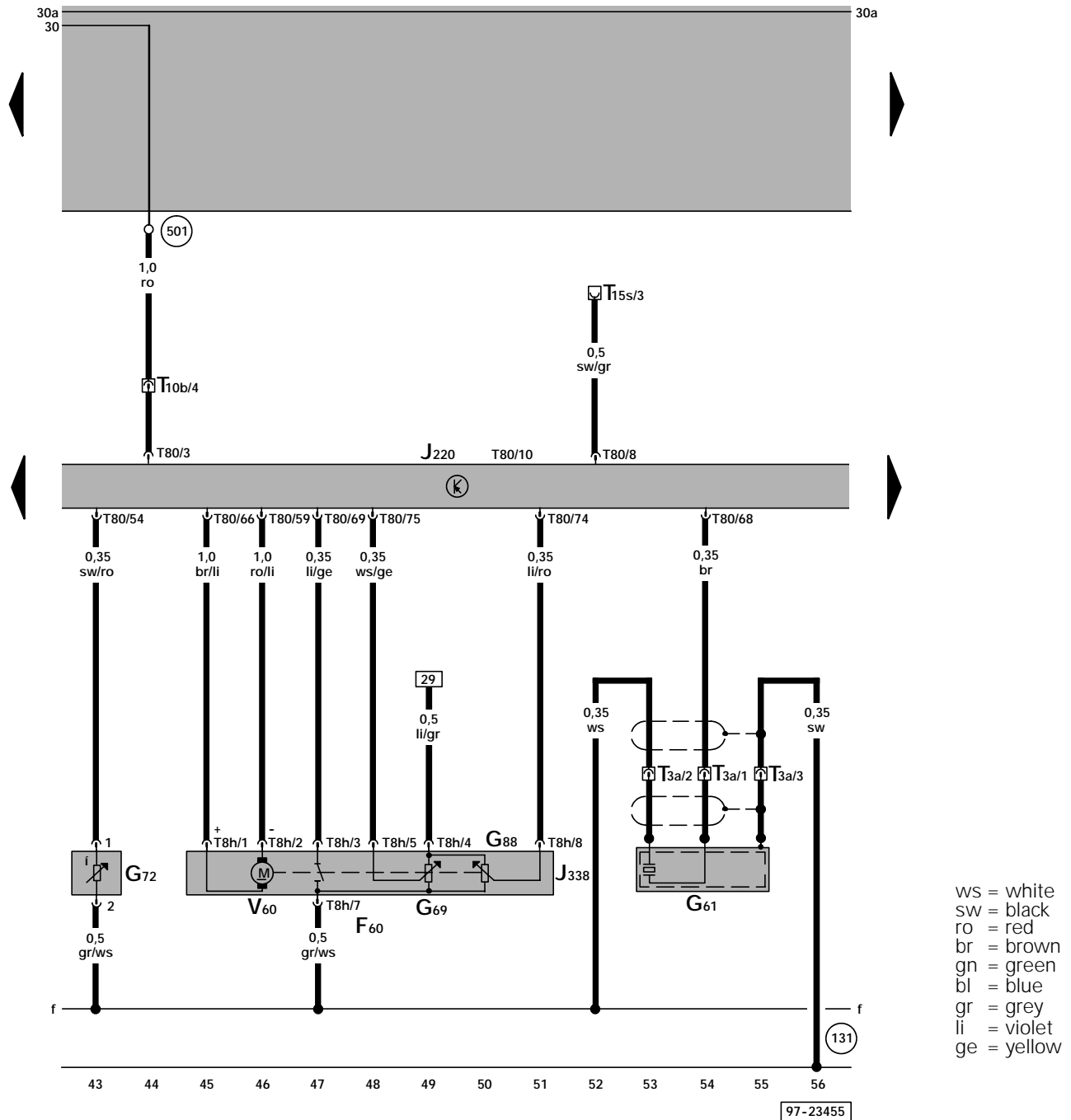

- F60 - Closed Throttle Position (CTP) Switch
- G61 - Knock Sensor (KS) 1
- G69 - Throttle Position (TP) Sensor
- G72 - Intake Air Temperature (IAT) Sensor
- G88 - Throttle Position (TP) Sensor
- J220 - Motronic Engine Control Module (ECM)
- J338 - Throttle Valve Control Module
- T3a - 3-Pin Connector, green, on firewall, left
- T8h - 8-Pin Connector, black, on throttle valve control module
- T10b - 10-Pin Connector, black, on protective housing for control module, in engine compartment, left
- T15s - 15-Pin Connector, red, on protective housing for control module, in engine compartment, left
- T80 - Connector, 80 point, on Motronic Engine Control Module (ECM)

- V60 - Throttle Position (TP) Actuator
- (131) - Ground connection -2-, in engine compartment wiring harness
- (501) - Screw connection -2- (30), on relay panel

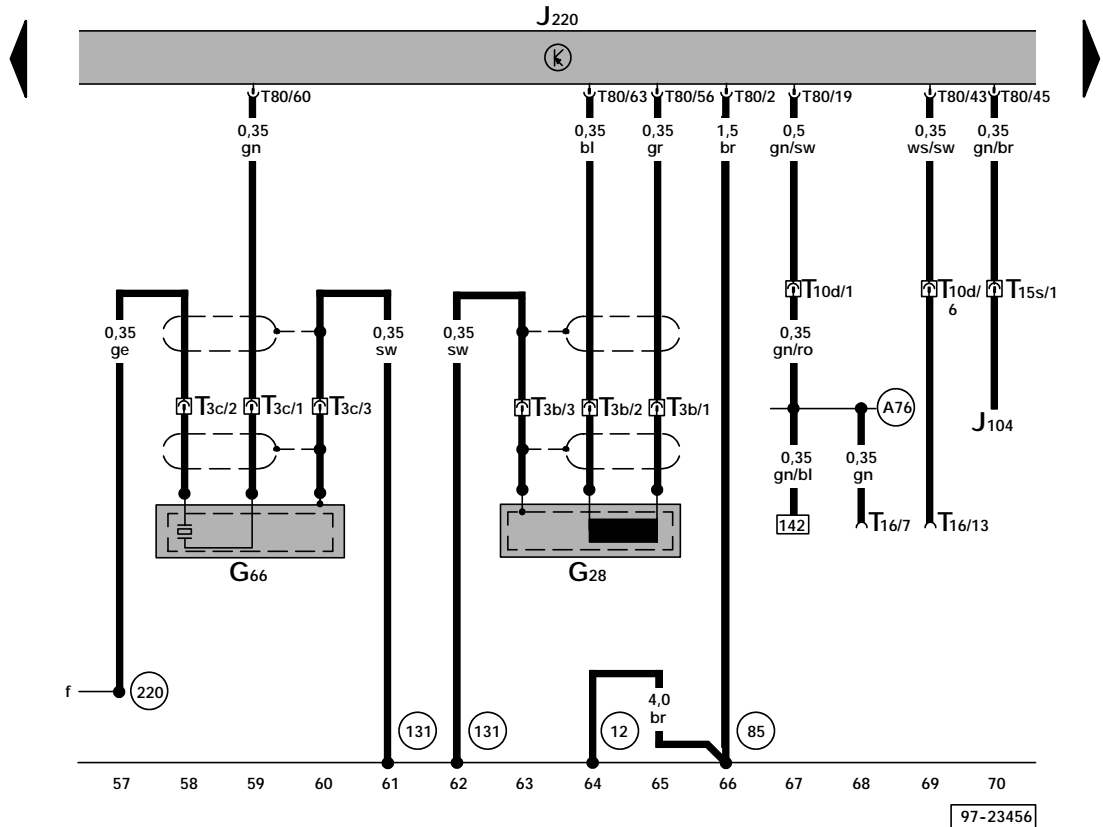

ws = white  
 sw = black  
 ro = red  
 br = brown  
 gn = green  
 bl = blue  
 gr = grey  
 li = violet  
 ge = yellow

- G28 - Engine Speed (RPM) Sensor
- G66 - Knock Sensor (KS) 2
- J104 - ABS Control Module (w/EDL)
- J220 - Motronic Engine Control Module (ECM)
- T3b - 3-Pin Connector, grey, on firewall, left
- T3c - 3-Pin Connector, blue, on firewall, left
- T6n - 6-Pin Connector, red, on protective housing for control module, in engine compartment, left
- T10d - 10-Pin Connector, brown, on protective housing for control module, in engine compartment, left
- T10e - 10-Pin Connector, yellow, on protective housing for control module, in engine compartment, left
- T15s - 15-Pin Connector, red, on protective housing for control module, in engine compartment, left
- T16 - 16-Pin Connector, Data Link Connector (DLC), below instrument panel, left

- T80 - Connector, 80 point, on Motronic Engine Control Module (ECM)
- (12) - Ground connection, in engine compartment, left
- (85) - Ground connection -1-, in engine compartment wiring harness
- (131) - Ground connection -2-, in engine compartment wiring harness
- (220) - Ground connection (sensor ground), in engine compartment wiring harness
- (A76) - Connector (K-diagnosis wire), in instrument panel wiring harness

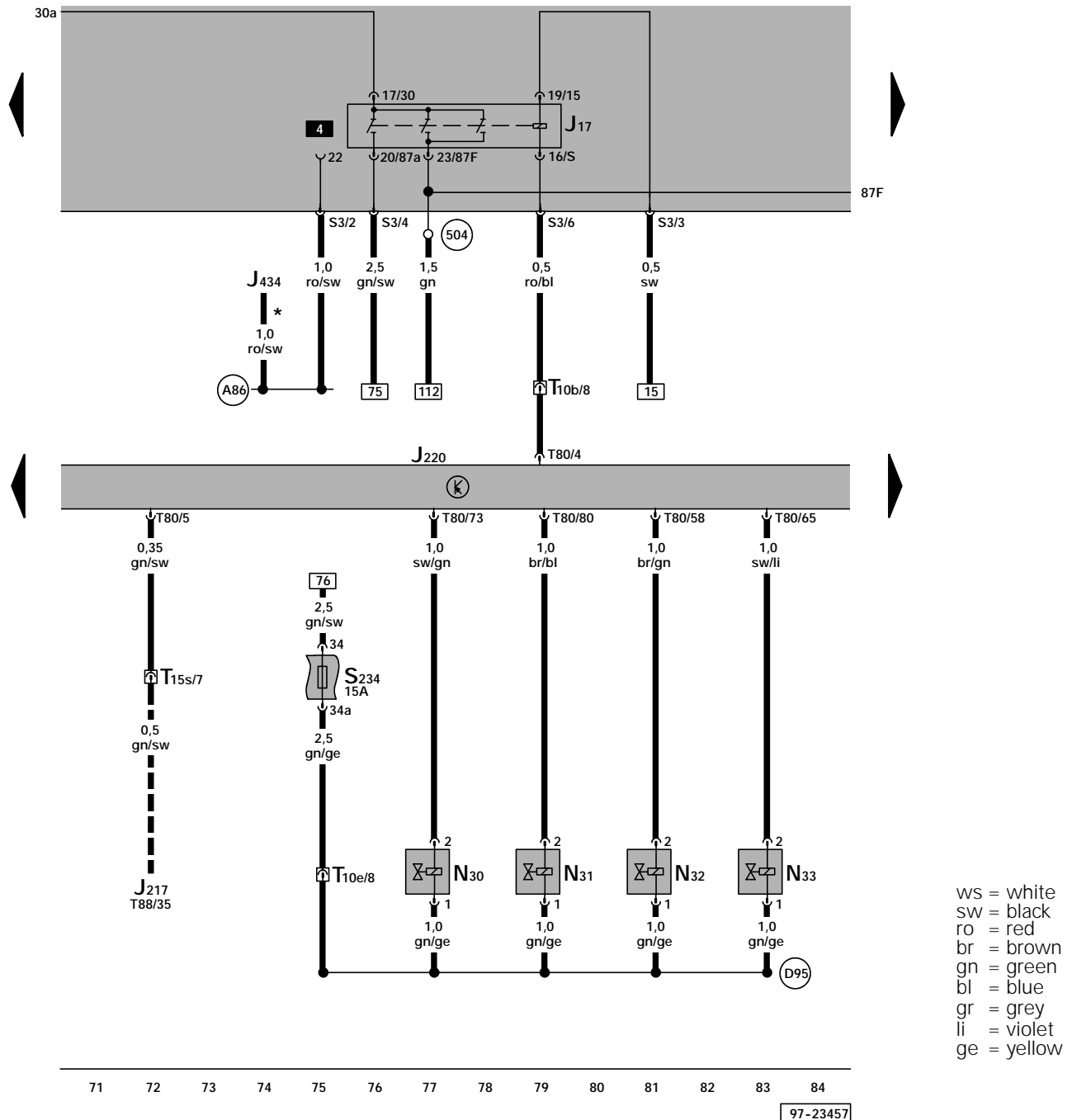

- J17 - Fuel Pump (FP) Relay, production control number (208)
- J217 - Transmission Control Module (TCM)
- J220 - Motronic Engine Control Module (ECM)
- J434 - Starting Interlock Realy (clutch position), manual transmission only
- N30 - Cylinder 1 Fuel Incjector
- N31 - Cylinder 2 Fuel Incjector
- N32 - Cylinder 3 Fuel Incjector
- N33 - Cylinder 4 Fuel Incjector
- S234 - Fuse 34 in fuse holder
- T10b - 10-Pin Connector, black, on protective housing for control module, in engine compartment, left
- T10e - 10-Pin Connector, yellow, on protective housing for control module, in engine compartment, left
- T15s - 10-Pin Connector, red, on protective housing for control module, in engine compartment, left

- T80 - Connector, 80 point, on Motronic Engine Control Module (ECM)
- T88 - Connector, 88 point, on Transmission Control Module (TCM)
- (504) - Screw connection (87F), on relay panel
- (A86) - Connection (50a), in instrument panel wiring harness
- (D95) - wire connection (injectors), in engine compartment wiring harness
- \* - manual transmission only
- - - automatic transmission only

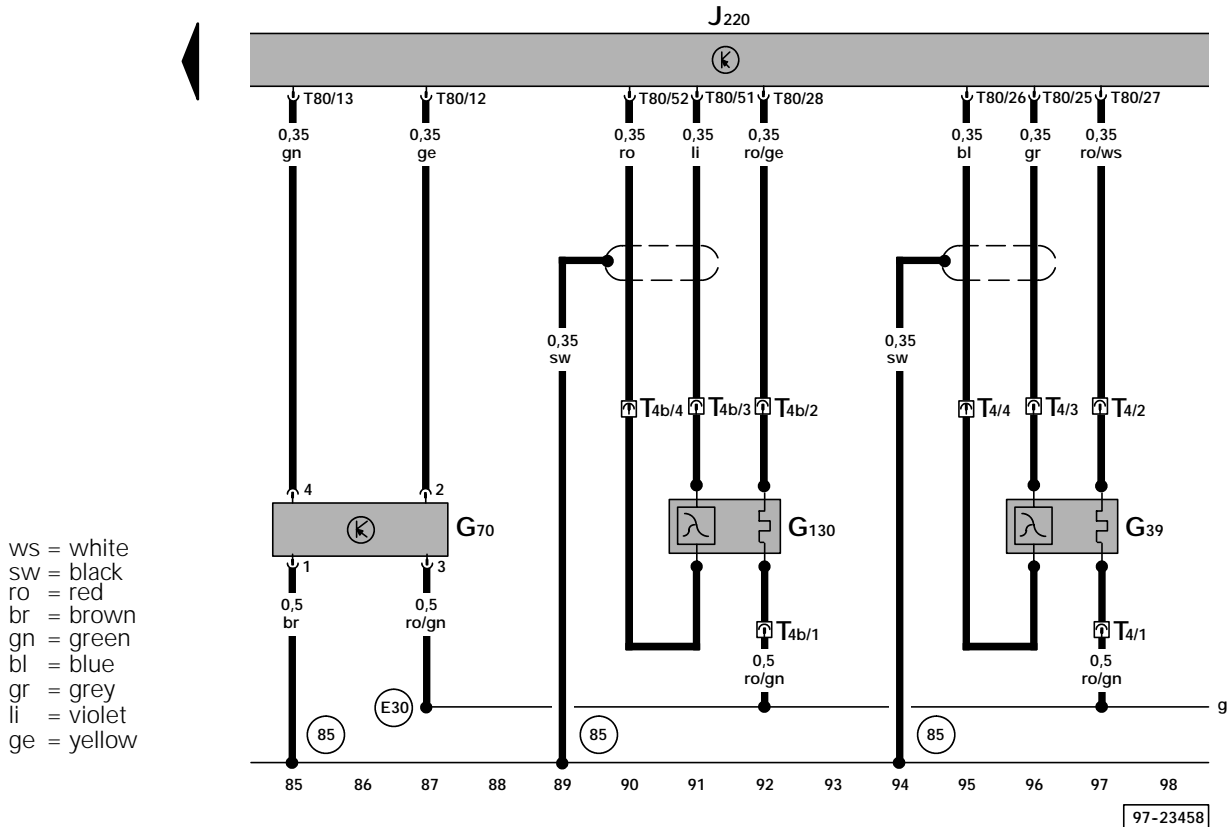

- G39 - Heated Oxygen Sensor (HO2S)
- G70 - Mass Air Flow (MAF) Sensor
- G130 - Oxygen Sensor (O2S) Behind Three Way Catalytic Converter (TWC)
- J220 - Motronic Engine Control Module (ECM)
- T4 - 4-Pin Connector
- T4b - 4-Pin Connector
- T80 - Connector, 80 point, on Motronic Engine Control Module (ECM)
- (85) - Ground connection -1-, in engine compartment wiring harness
- (E30) - Connector (87a), in wiring harness engine



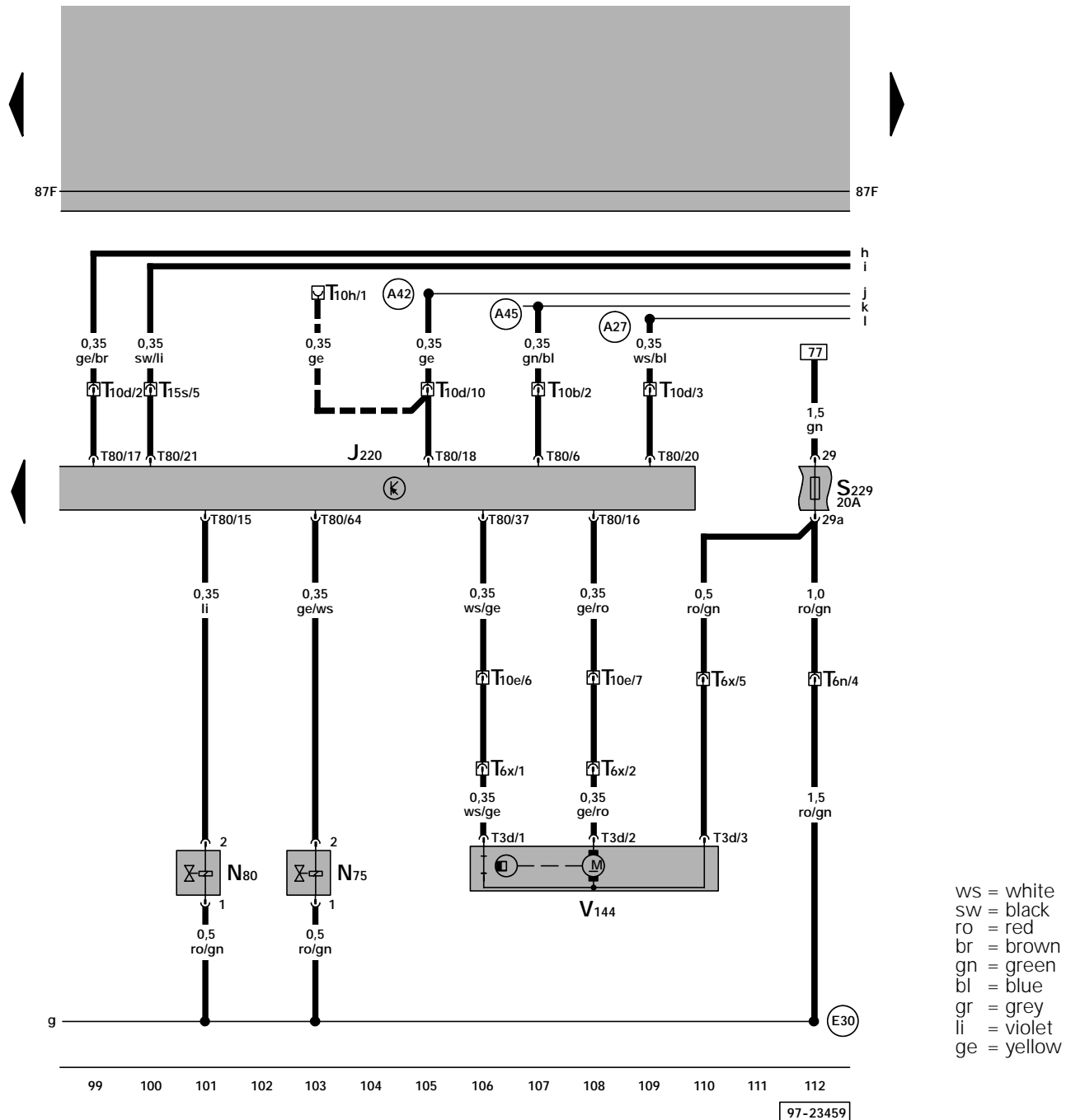

ws = white  
 sw = black  
 ro = red  
 br = brown  
 gn = green  
 bl = blue  
 gr = grey  
 li = violet  
 ge = yellow

- J220 - Motronic Engine Control Module (ECM)
- N75 - Wastegate Bypass Regulator Valve
- N80 - Evaporative Emission (EVAP) Canister Purge Regulator Valve
- S229 - Fuse 29 in fuse holder
- T3d - 3-Pin Connector, black
- T6n - 6-Pin Connector, red, on protective housing for control module, in engine compartment, left
- T6x - 6-Pin Connector, brown, connector station A-pillar, right
- T10b - 10-Pin Connector, black, on protective housing for control module, in engine compartment, left
- T10d - 10-Pin Connector, brown, on protective housing for control module, in engine compartment, left
- T10e - 10-Pin Connector, orange, on protective housing for control module, in engine compartment, left
- T15s - 15-Pin Connector, red, on protective housing for control module, in engine compartment, left
- T80 - Connector, 80 point, on Motronic Engine Control Module (ECM)
- V144 - Leak Detection Pump (LDP)
- (A27) - Wire Connection (vehicle speed signal), in instrument panel wiring harness
- (A42) - plus connection (fuel gauge), in instrument panel wiring harness
- (A45) - wire connection (RPM-signal), in instrument panel wiring harness
- (E30) - Connector (87a), in wiring harness engine
- - - automatic transmission only

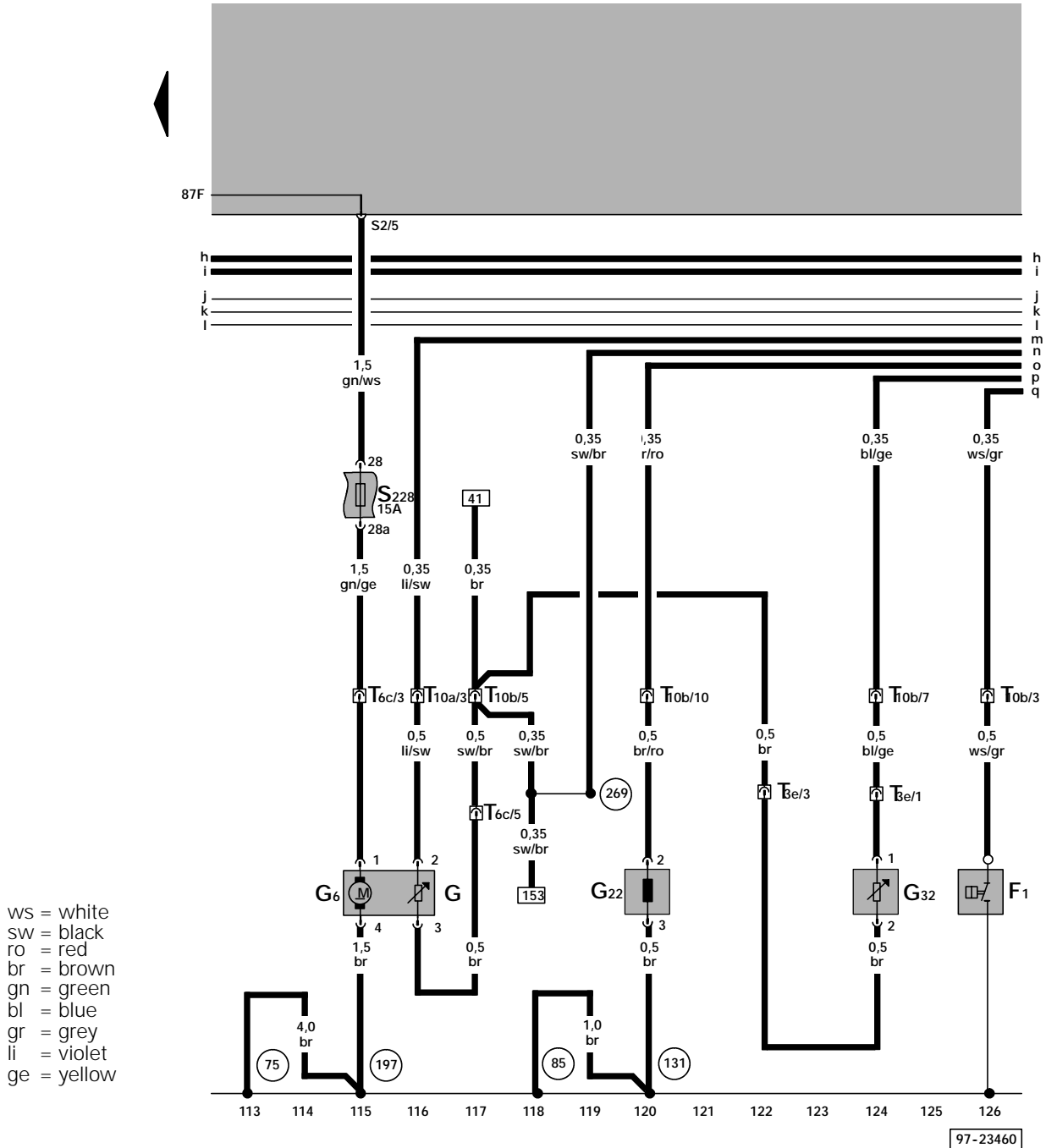

ws = white  
 sw = black  
 ro = red  
 br = brown  
 gn = green  
 bl = blue  
 gr = grey  
 li = violet  
 ge = yellow

- F1 - Oil Pressure Switch
- G - Sender for fuel gauge
- G6 - Fuel Pump (FP)
- G22 - Speedometer Vehicle Speed Sensor (VSS)
- G32 - Engine Coolant Level (ECL) Sensor
- S228 - Fuse 28 in fuse holder
- T3e - 3-Pin Connector, in engine compartment, left front
- T6c - 6-Pin Connector, blue, connector station A-pillar, left
- T10a - 10-Pin Connector, brown, connector station A-pillar, left
- T10b - 10-Pin Connector, black, on protective housing for control module, in engine compartment, left
- T10e - 10-Pin Connector, yellow, on protective housing for control module, in engine compartment, left

- 75 - Ground connection, on right rear pillar
- 85 - Ground connection -1-, in engine compartment wiring harness
- 131 - Ground connection -2-, in engine compartment wiring harness
- 197 - Ground connection -4-, in wiring harness rear
- 269 - Ground connection (sensor ground) -1-, in instrument panel wiring harness

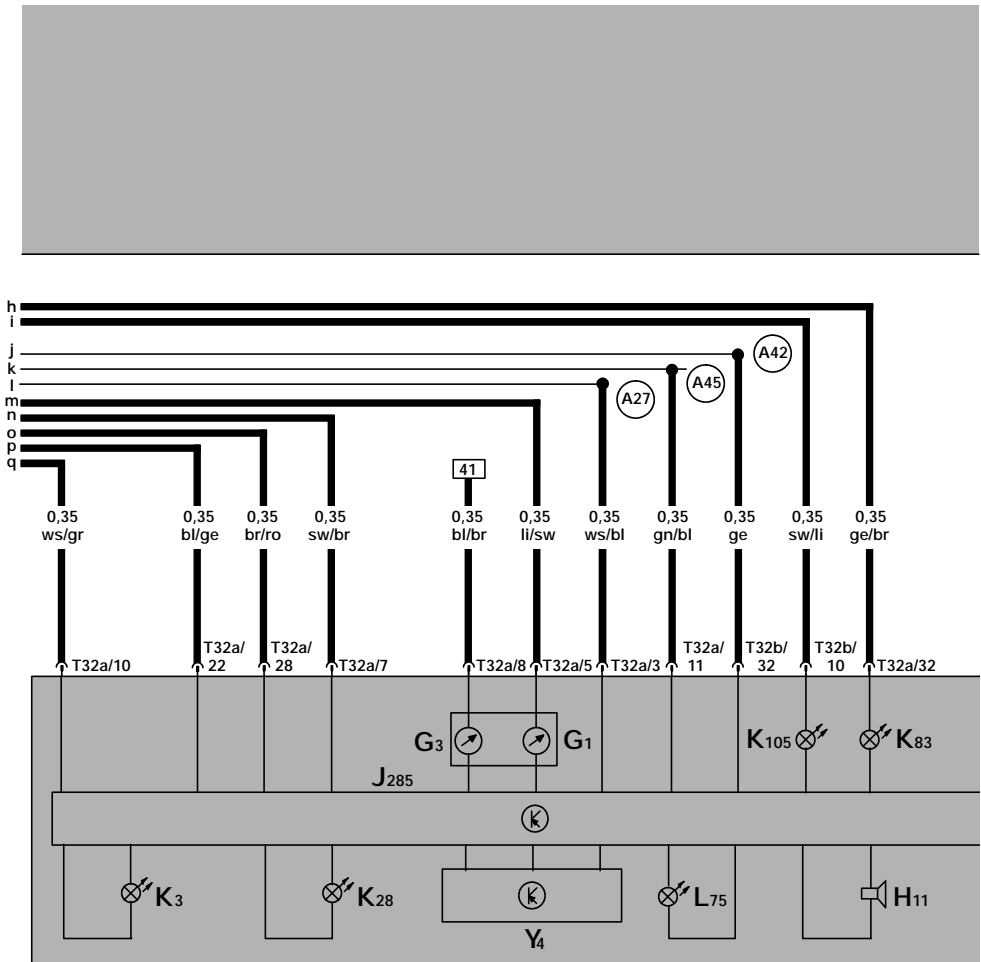

ws = white  
 sw = black  
 ro = red  
 br = brown  
 gn = green  
 bl = blue  
 gr = grey  
 li = violet  
 ge = yellow

127 128 129 130 131 132 133 134 135 136 137 138 139 140 97-23461

- G1 - Fuel gauge
- G3 - Engine Coolant Temperature (ECT) Gauge
- H11 - Oil Pressure Warning Buzzer
- J285 - Control module with indicator unit in instrument panel insert
- K3 - Oil Pressure Warning Light
- K28 - Engine Coolant Level/Temperature (ECL/ECT) Warning Light
- K83 - Malfunction Indicator Lamp (MIL)
- K105 - Low Fuel Level Warning Light
- L75 - Digital Display Light
- T32a - 32-Pin Connector, blue, on instrument cluster
- T32b - 32-Pin Connector, green, on instrument cluster
- Y4 - Odometer Display

- A42 - plus connection (fuel gauge), in instrument panel wiring harness
- A45 - wire connection (RPM-signal), in instrument panel wiring harness

- A27 - Wire Connection (vehicle speed signal), in instrument panel wiring harness

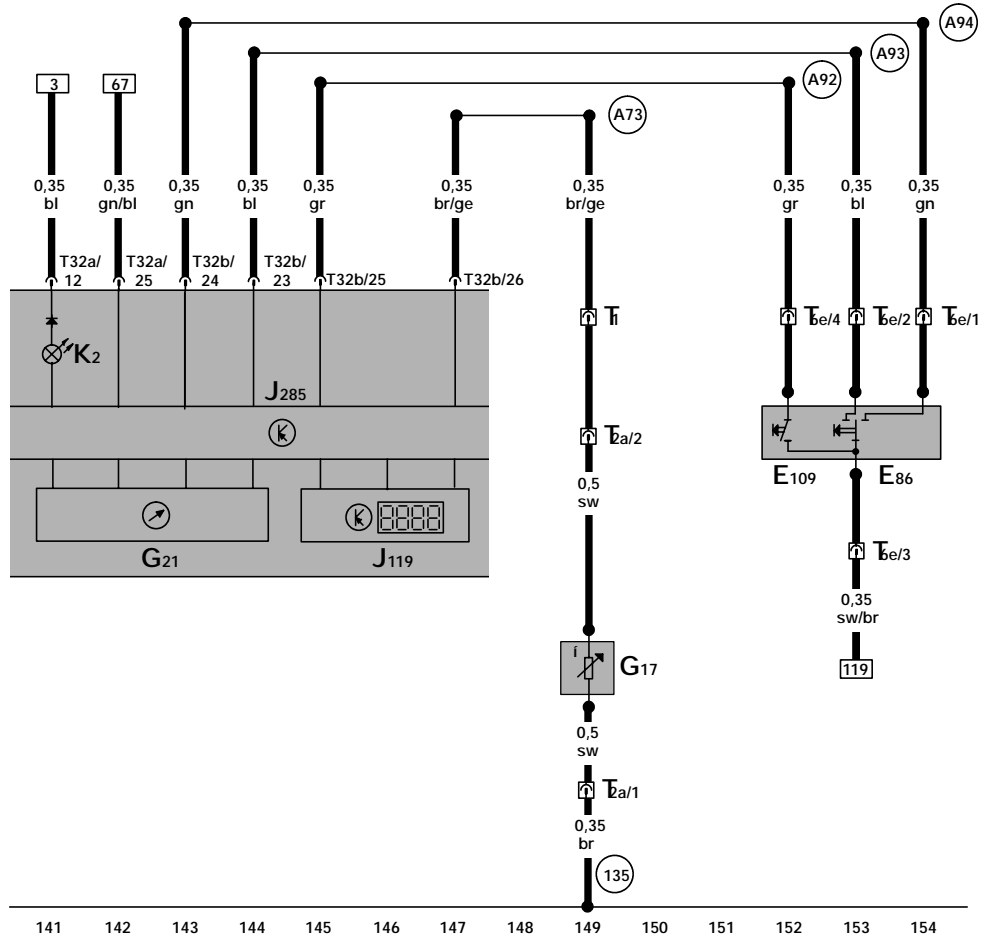

ws = white  
 sw = black  
 ro = red  
 br = brown  
 gn = green  
 bl = blue  
 gr = grey  
 li = violet  
 ge = yellow

97-23462

- E86 - Multi-Function Indicator Mode Select Switch
- E109 - Multi-Function Indicator Memory Switch
- G17 - Outside Air Temperature Sensor  
(use correspond wiring diagram by vehicles with air conditioning)
- G21 - Speedometer
- J119 - Multi-function Indicator (MFI)
- J285 - Control module with indicator unit in instrument panel insert
- K2 - Generator (GEN) Warning Light
- T1 - Single Connector, brown, connector station A-pillar, left
- T2a - Double Connector, in engine compartment, left front
- T6e - 6-Pin Connector, black, behind steering column switch cover

- T32a - 32-Pin Connector, blue, on instrument cluster
- T32b - 32-Pin Connector, green, on instrument cluster
- (135) - Ground connection, -2-, in instrument panel wiring harness
- (A73) - Connector (outside temperature indicator), in instrument panel wiring harness
- (A92) - Connector (MFI-Reset), in instrument panel wiring harness
- (A93) - Connector -1- (MFI), in instrument panel wiring harness
- (A94) - Connector -2- (MFI), in instrument panel wiring harness