

# ŠKODA

**C**ontroller

**A**rea

**N**etwork

a serial  
**bus system**  
designed specifically  
for use in vehicles

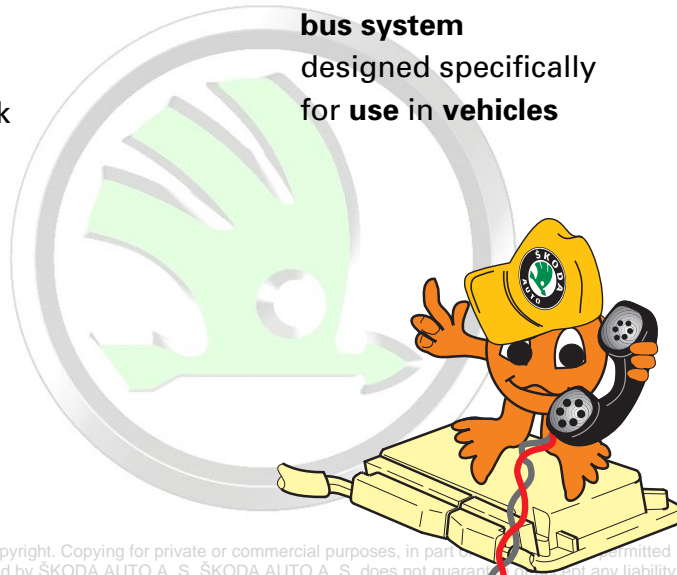

Protected by copyright. Copying for private or commercial purposes, in part or in full, is not permitted unless authorised by ŠKODA AUTO A. S. ŠKODA AUTO A. S. does not guarantee or accept any liability with respect to the correctness of information in this document. Copyright by ŠKODA AUTO A. S. ©

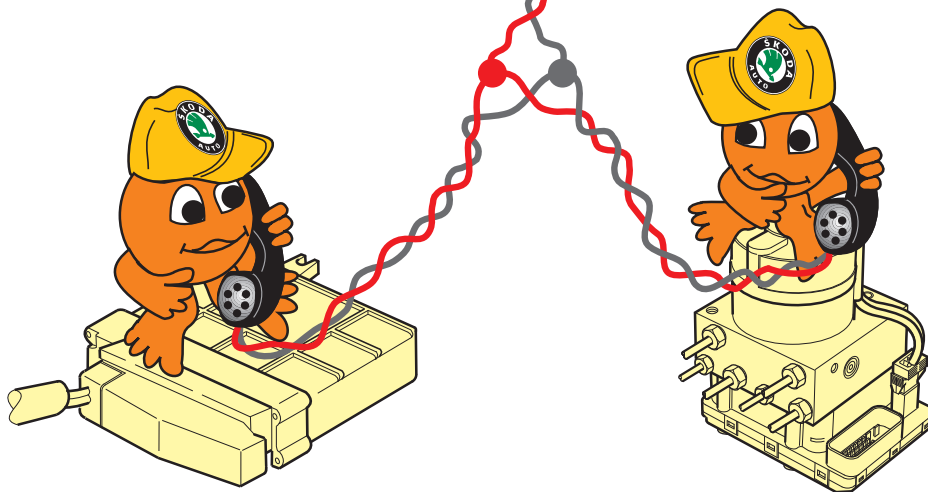

With the CAN bus system one of the latest developments of vehicle electronics engineering has been implemented in practice in the ŠKODA OCTAVIA.

In this Self Study Program we wish to provide you with general explanations of this new feature and present the systems which have been implemented in the OCTAVIA.

# Contents

■	<b>Introduction</b>	<b>4</b>
■	<b>CAN databus</b>	<b>5</b>
■	<b>Data transfer</b>	<b>10</b>
■	<b>Function</b>	<b>12</b>
■	<b>Drive CAN databus</b>	<b>17</b>
■	<b>Convenience electronics CAN databus</b>	<b>22</b>
■	<b>Test your knowledge</b>	<b>24</b>
■	<b>CAN bus dictionary</b>	<b>26</b>

Protected by copyright. Copying for private or commercial purposes, in part or in whole, is not permitted unless authorised by ŠKODA AUTO A. S. ŠKODA AUTO A. S. does not guarantee or accept any liability with respect to the correctness of information in this document. Copyright by ŠKODA AUTO A. S. ©

**You will find notes on inspection and maintenance, setting and repair instructions in the Workshop Manual.**



# Introduction

A large number of electronic subsystems are incorporated in a vehicle to satisfy the high demands in terms of vehicle safety, ride comfort, emissions performance and fuel consumption.

Each electronic system has its own digital control unit for this purpose, for example for fuel injection/ignition, for ABS or for gear box control.

Each control unit in turn has its own specific sensors and actuators.

The processes which are controlled by the individual control units have to be matched and synchronized to each other, for example if the engine torque has to be reduced during gear shifts by altering the ignition timing. The traction control system, which reduces the input torque at the driving wheels which are tending to slip, is a further example of this.

It is beneficial to have all the control units make common use of the sensors.

Consequently, the transfer of information between the control units is of major significance for the entire vehicle system. This data transfer is constantly growing.

A simple solution is required for information transfer, however, to ensure that the electrical/electronic systems nevertheless remain comprehensible and do not take up too much space.

The CAN databus from Bosch is such a solution.

It has been specifically developed for vehicles and is being increasingly used at SKODA.

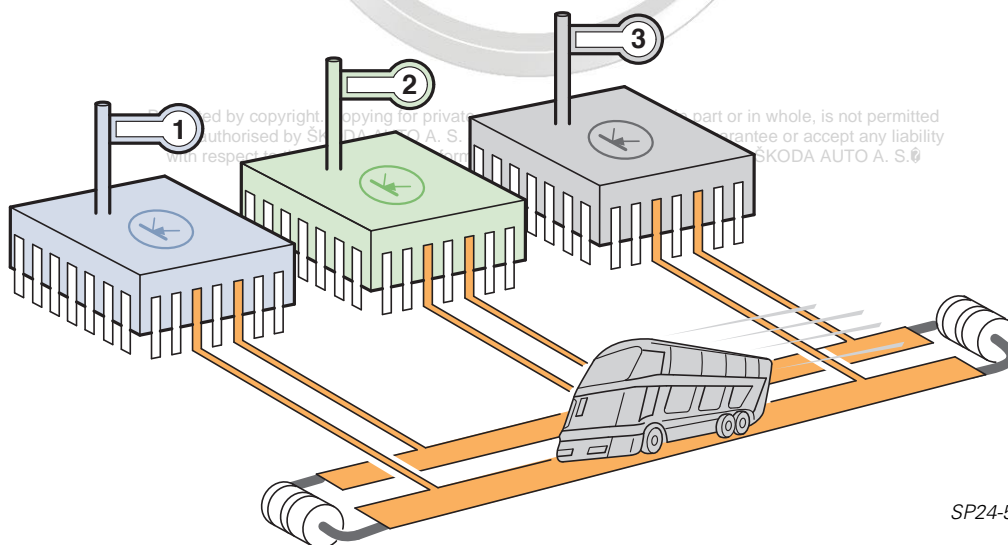

SP24-5

A CAN databus can be looked upon as similar to an omnibus.

Just as an omnibus transports a large number of passengers, the CAN databus transports a wide range of information.



## Note:

Two terms which will be our constant companions:

**BUS** = a system for transporting and distributing data

**CAN** = a bus system specifically developed for vehicles.

# CAN databus

## The 2 possibilities for transferring data in a vehicle

### – with single wires

In this case the transfer of information between the individual control units is conducted over a separate wire for each information.

Consequently, each additional item of information also means an increase in the number of wires and the number of pins at the control units.

# ŠKODA

This type of data transfer is only a practical proposition if dealing with the limited number of items of information which have to be exchanged.

The diagram shows data transfer based on this principle - each item of information with its own wire. A total of five wires are required in this case.

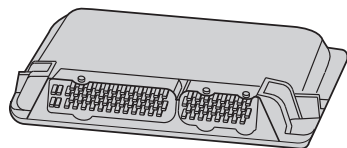

Up shifts/down shifts

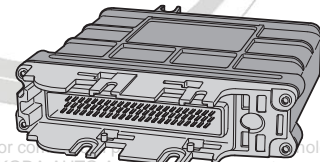
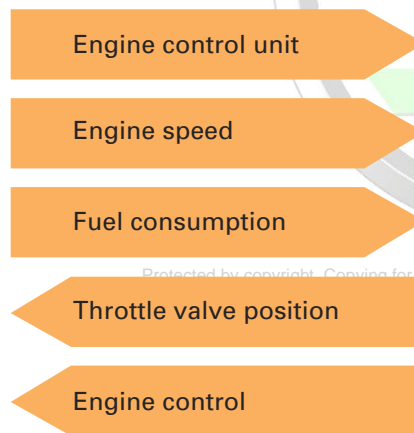

Automatic gear box control unit

Protected by copyright. Copying for private or commercial use, in whole or in part, is not permitted without the written permission of ŠKODA AUTO A. S. ŠKODA AUTO A. S. does not guarantee or accept any liability for the accuracy of the information in this document. Copyright by ŠKODA AUTO A. S. © SP24-6

### – with CAN databus

This type of information transfer makes use of two wires for transmitting all the information.

The same data are transmitted over the two bidirectional wires. This takes place irrespective of the number of control units and items of information.

Data transfer using the CAN databus is the most practical method if it is necessary to transfer a large flow of information between a large number of control units.

The diagram shows the two-wire system - all the information flows over two wires.

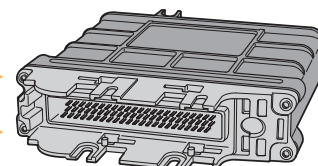
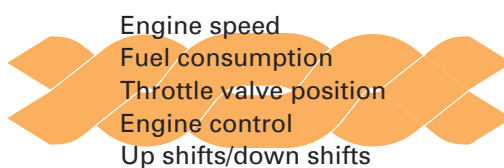
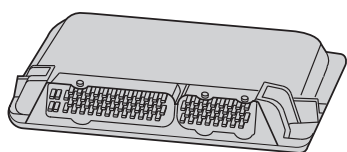

SP24-7

# CAN databus

## The principle of data transfer

We can imagine data transfer using the CAN databus as a kind of telephone conference call. The principle is the same.

One user - control unit 1 - "speaks" its message into the network of wires while the other users "listen to" this message and analyze it.

One of the users finds this message interesting and applicable, and uses it. The other users do not, and remain passive.

As you see, it is possible for only two or also more than three users to be linked to the "telephone conference call".

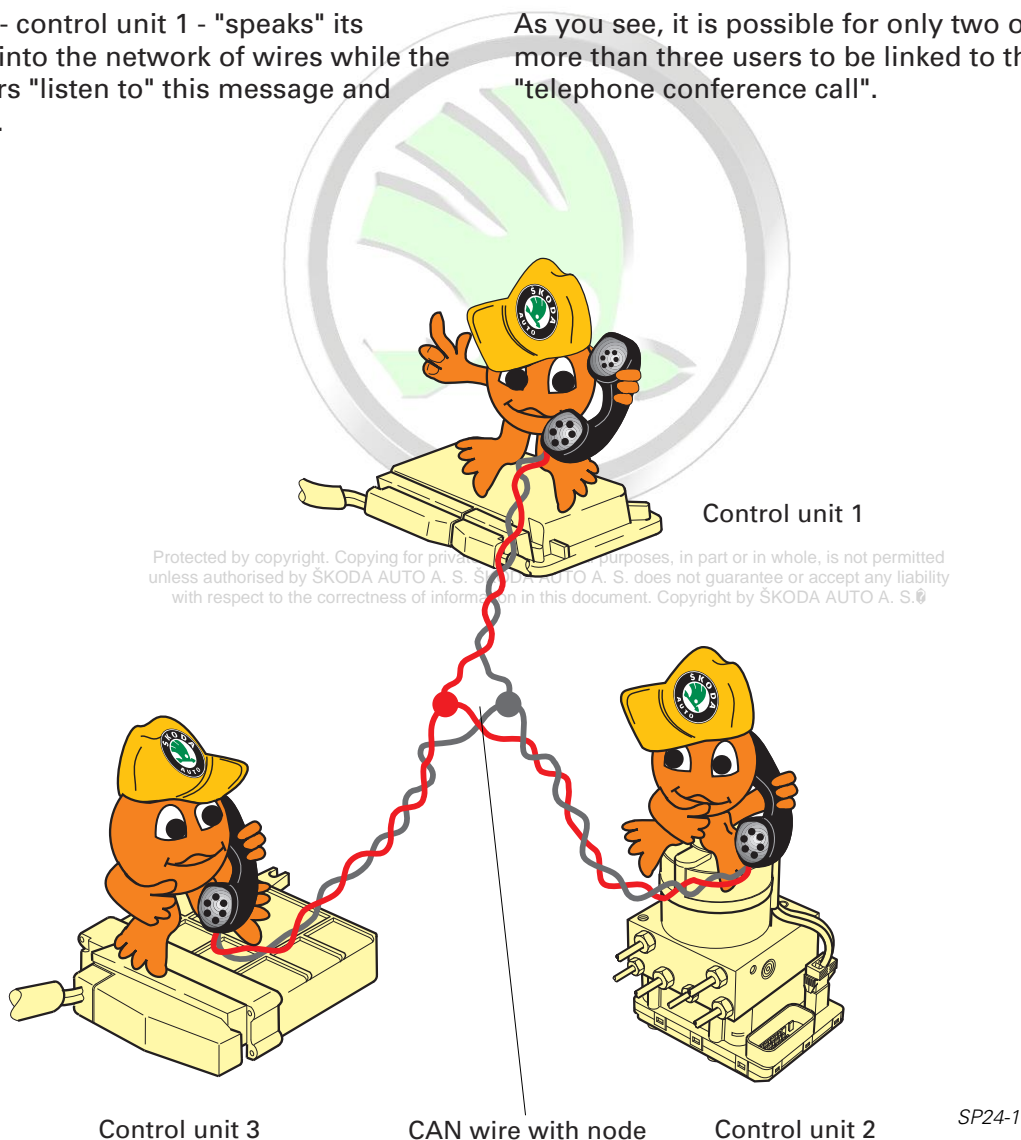

### Note:

There are also different technical versions of merging the wires in the control unit. This is the case, for example, in the Motronic control unit of the Audi A8!

## The CAN databus

is an example of this type of data transfer between control units. It links individual control units to form a complete system.

The more information a control unit has regarding the status of the entire system, the better able it is to harmonize the individual functions.

There are three principal fields of applications for CAN in motor vehicles.

Two of these are presently implemented in the SKODA OKTAVIA:

- drive databus
- convenience databus

### Drive databus:

covers the networking of the control units for

- the engine control unit
- the ABS control unit
- the automatic gear box control unit

### Convenience electronics databus:



comprises

- the central control unit
- the door control unit

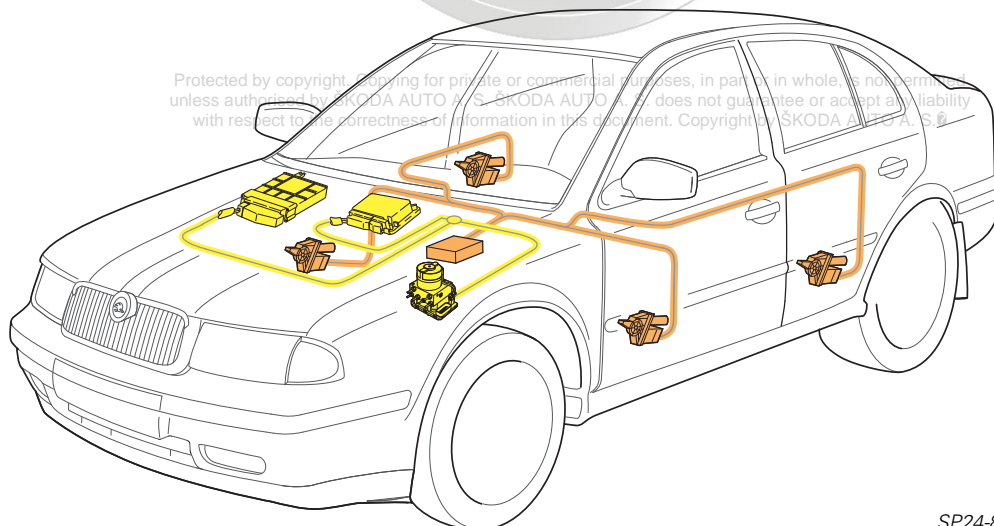
The third area is **in preparation - the mobile communication system** (e.g. car radio, mobile phone, navigation system and central operating and display unit).



SP24-8

-  Convenience electronics complete system
-  Drive complete system

### The advantages of the CAN databus:

- greatly simplified wiring
- very rapid transfer of data between the control units
- gain in space as a result of compact control units and small control unit connectors
- low error rate as the messages transmitted are constantly verified by the control units
- In order to enlarge the data protocol with additional information, it is only necessary to carry out modifications to the software.
- The CAN databus is standardized worldwide. For this reason, it is also possible for control units of various manufacturers to interchange their data over this bus.

# CAN databus

## The components of the CAN databus

The CAN databus consists of:

- a controller
- a transceiver
- two databus terminals
- two databus lines.

With the exception of the databus lines, all the components are integrated in the control units. The function of the control units has not changed compared to the previous ones.

### The tasks of the components

#### The CAN controller

receives the data to be transmitted from the microcomputer in the control unit.

It readies them and passes them on to the CAN transceiver.

In the same way, it receives data from the CAN transceiver, likewise readies them and passes them on to the microcomputer in the control unit.

#### The CAN transceiver

is a transmitter and receiver at the same time. It converts the data from the CAN controller into electrical signals and transmits them along the databus lines.

In exactly the same way, it receives data and converts them for the CAN controller.

#### Databus terminal

is a resistor. It prevents the transmitted data returning from the ends of the data bus lines and falsifying the subsequent data.

#### Data bus lines

are bidirectional and are used for transferring the data.

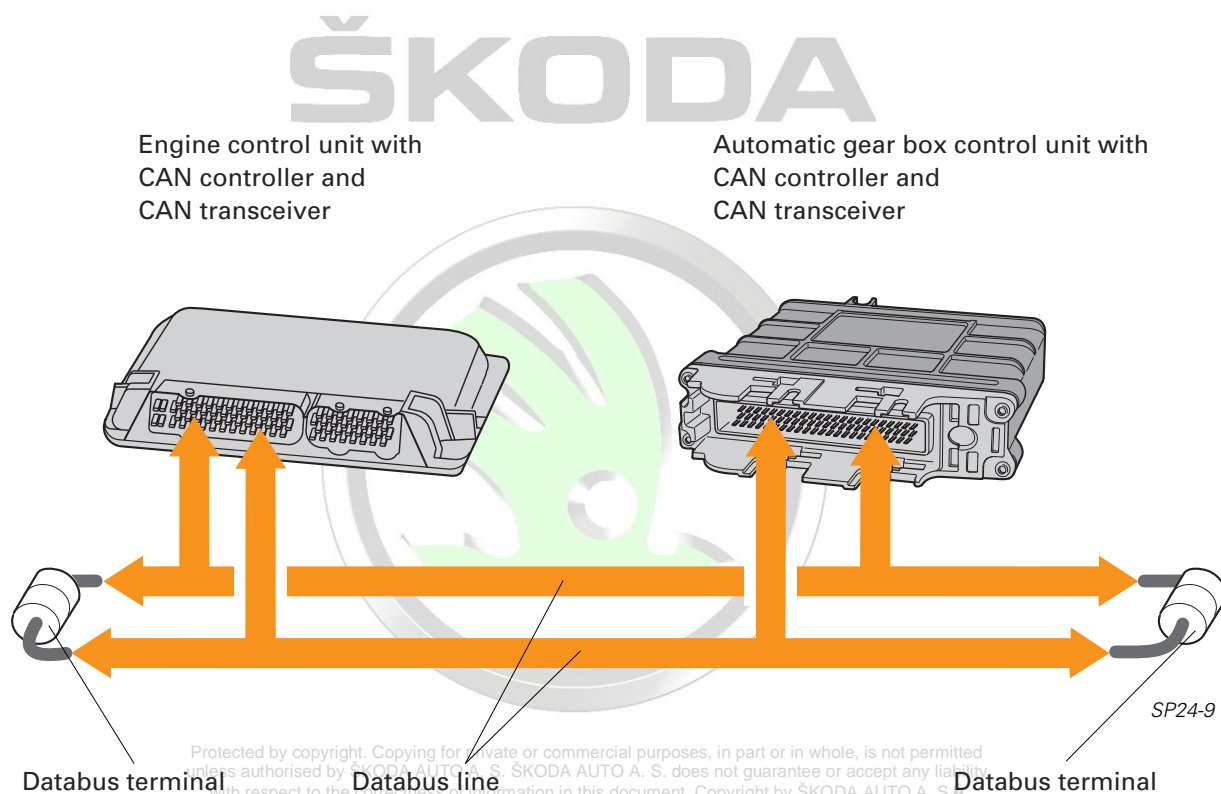

When using a databus, the receiver is not defined. The data are transmitted over the databus and, as a rule, are received and analyzed by all the users.



**Note:**  
**If two control units wish to send their message simultaneously, the one with the highest priority takes first place.**  
**For example, ABS data have a higher priority than gear box data.**  
**(See also the section on databus assignment).**

## Flow of data transfer

### Readying data

The starting point of a message (data) is always a control unit. It hands over the data to be transmitted to its CAN controller.

### Verifying data

The control units verify whether they require the data received for their functions, or not.

### Transmitting data

The CAN transceiver receives these data from the CAN controller, converts them into serial electrical signals and transmits them.

### Adopting data

If the data are important, they are adopted and processed, otherwise they are ignored.

### Receiving data

All the other control units which are networked through the CAN databus, are then transformed into receivers.

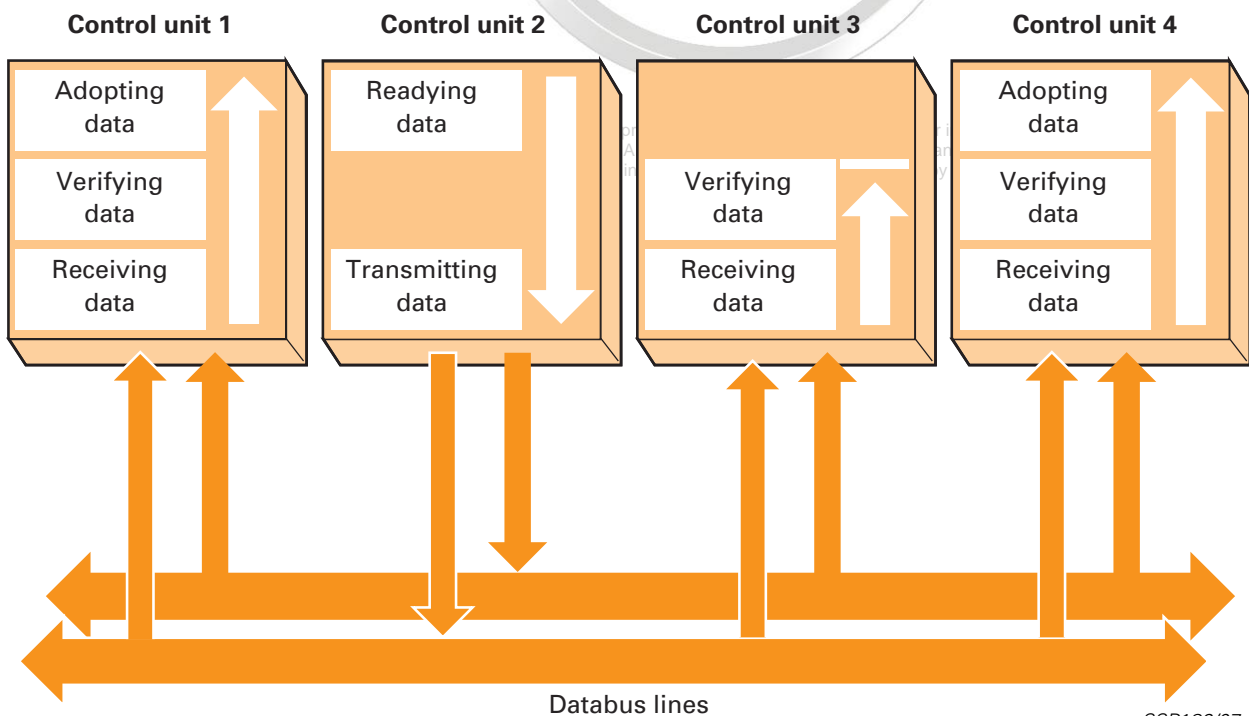

SSP186/07



# Data transfer

## What does the CAN databus transfer?

The CAN databus transfers a data protocol - also known as a message - between the control units in very short time intervals.

This data protocol is always structured in accordance with a standard data frame. This data frame consists of **seven** consecutive fields.

### The data protocol

It consists of a variety of bits positioned one after the other. The number of bits of a data protocol depends on the size of the data field.



#### Note:

**A bit is the smallest unit of information. In electronics, this information can always only have the value of "0" or "1" or "yes" or "no", respectively.**

The graph below shows the schematic structure of a data protocol. The structure is identical on both databus lines.

In order to simplify matters in the Self-study Program, only one databus line is shown in the illustrations.

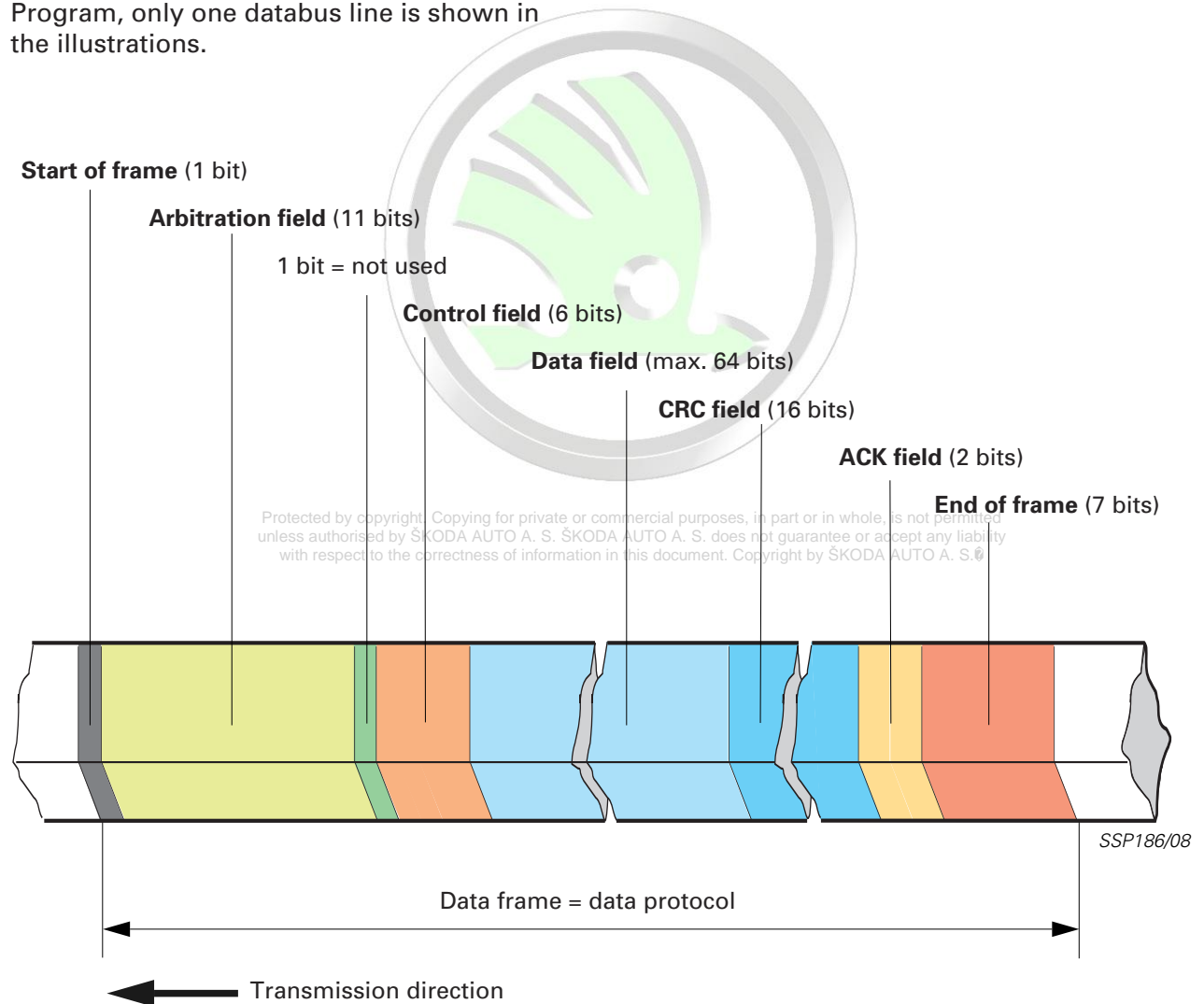

## The seven fields

The **start of frame** marks the beginning of the data protocol.

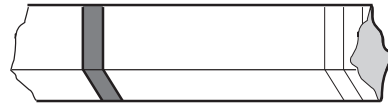

SSP186/09

What is defined in the **arbitration field** is the priority of the data protocol. If, for example, two control units wish to transmit their data protocol simultaneously, the one with the higher priority is transmitted first. In addition, the contents of the message (e.g. engine speed) are identified.

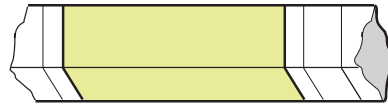

SSP186/10

The **control field** contains the number of the items of information in the data field, in the form of a code. Each receiver is thus able to verify whether it has received all the items of information.

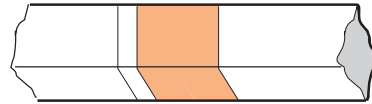

SSP186/11

What is transmitted in the **data field** are the items of information which are of importance for the other control units. This field features the highest information content from 0 to 64 bits (= 0 to 8 bytes).

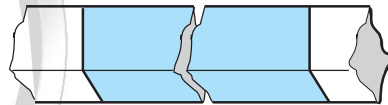

SSP186/12

The **CRC field** is used for detecting transmission faults.

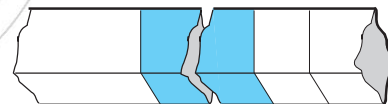

SSP186/13

In the **ACK field** the receiver's signal to the transmitter that they have correctly received the data protocol. If a fault is detected, they immediately advise this to the transmitter, whereupon the transmitter repeats its message.

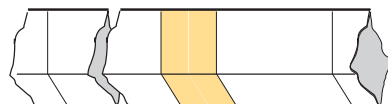

SSP186/14

In the **end of frame** the transmitter verifies its data protocol and confirms to the receiver whether it is correct. If it is faulty, the transmission is immediately aborted and the message transmitted once again. The data protocol is completed.

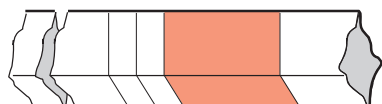

SSP186/15

# Function

## How is a data protocol produced?

The data protocol consists of several consecutive bits. Each bit can only always have the status "0" or "1". It is possible to use 0 or 1 in the binary numerical system to represent any desired number.

Here is a model example to explain the situation.

### Switch and lamp

The switch can be used to switch a lamp on or off. The switch can be regarded as the information transmitter, the lamp as the information receiver. Consequently, there are only two logical states:

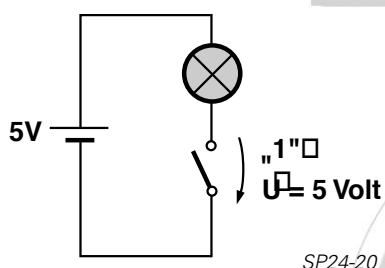

- switch opened
  - lamp does not come on
  - voltage through the switch is 5 volts
- We designate this state with "1"**

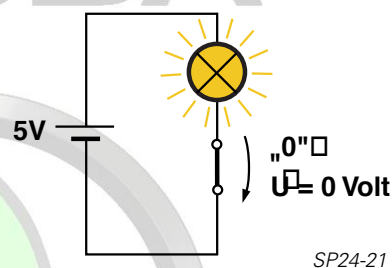

- switch closed
  - lamp on
  - voltage through switch is 0 volts
- We designate this state with "0"**

This basically operates in the same way when dealing with the **CAN databus**.

**The Transmitting Unit of the CAN Transceiver** can likewise generate two different states for the bit (we once again regard the switch as the transmitter, and the lamp as the receiver).

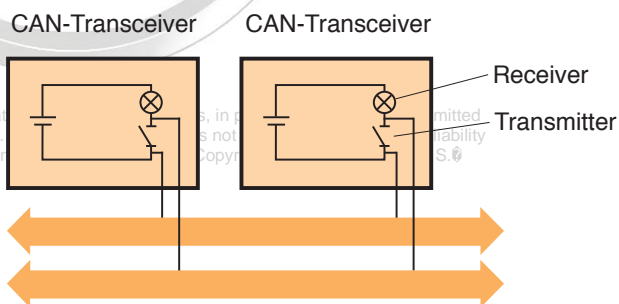

### Bit with state "1"

- transmitter of transceiver inactive (equals switch opened)
- voltage on databus approx. 5 volts

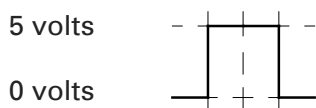

### Bit with state "0"

- transmitter of transceiver active (equals switch closed)
- voltage on the databus approx. 0 volts



If we have two bits there are four different versions.  
 An information can be assigned to each version.  
 This is then mandatory for all the control units.

The table shows how information can be formed and transmitted with two successive bits. The example shown in the chart is intended to illustrate the position of the throttle valve. It is also, however, possible to assign logical states of movement, such as window open, window closed, or window moving.

Possible version	First bit	Second bits	Graphical	Throttle valve position information
One	0 volts	0 volts		20°
Two	0 volts	5 volts		40°
Three	5 volts	0 volts		60°
Four	5 volts	5 volts		80°

Each additional bit doubles the number of items of information.  
 The more bits are arranged in succession, the more items of information can be transmitted.

In the drive databus, for example, the throttle valve opening angle is formed in stages of 0.4° using 8 bits (refer also to p. 19).

Bit versions with 1 bit	Possible information	Bit versions with 2 bits	Possible information	Bit versions with 3 bits	Possible information
0 volts	10°	0 volts, 0 volts	10°	0 volts, 0 volts, 0 volts	10°
5 volts	20°	0 volts, 5 volts	20°	0 volts, 0 volts, 5 volts	20°
		5 volts, 0 volts	30°	0 volts, 5 volts, 0 volts	30°
		5 volts, 5 volts	40°	0 volts, 5 volts, 5 volts	40°
				5 volts, 0 volts, 0 volts	50°
				5 volts, 0 volts, 5 volts	60°
				5 volts, 5 volts, 0 volts	70°
				5 volts, 5 volts, 5 volts	80°

# Function

## The CAN databus assignment

If several control units wish to transmit the data protocol simultaneously, it is necessary to decide which protocol has priority. The data protocol with the highest priority is transmitted first.

Consequently, the protocol of the ABS/EDL control unit is more important, for safety reasons.

The protocol of the automatic gear box control unit regarding ride comfort is, for example, less important.



### What is the procedure for assigning?

Each bit has a state.

It is either        logical "0",  
                              with priority,  
or                        logical "1",  
                              no priority.

A priority of the data protocol is the result of the arrangement of the different bits in the message.

Bit with	State	
0 volts	logical 0	with priority
5 volts	logical 1	no priority

### How is the priority of the data protocol recognized?

A code, consisting of 11 bits, is assigned to a data protocol in line with its priority in the arbitration field.

The table shows the priority of three data protocols.

<b>Brake</b>	001	1010 0000
<b>Engine</b>	010	1000 0000
<b>Gear box</b>	100	0100 0000

Protected by copyright. Copying for private or commercial purposes, in part or in whole, is not permitted unless authorised by ŠKODA AUTO A. S. ŠKODA AUTO A. S. does not guarantee or accept any liability with respect to the correctness of information in this document. Copyright by ŠKODA AUTO A. S. ©

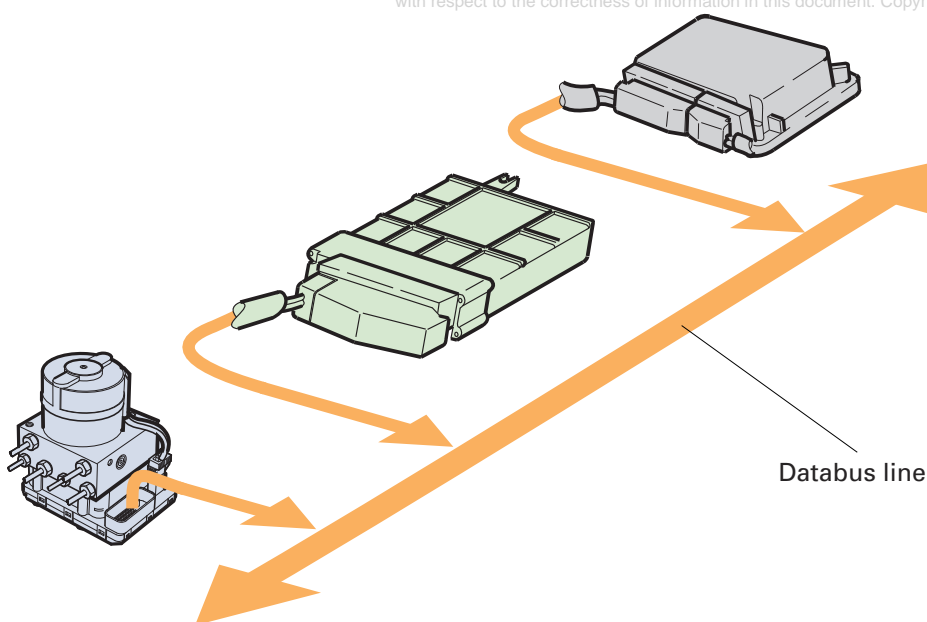

SP24-15

All three control units begin at the same time with the transmission of their data protocol. Parallel to this, they compare bit for bit on the databus line.

If the control unit recognizes a bit with priority in the arbitration field compared to its own without priority, it stops transmitting and becomes the receiver.

**Example:**

**Bit 1 in arbitration field**

- The automatic gear box control unit transmits a bit without priority and detects on the databus line a bit with priority. It consequently loses its assignment and become a receiver. Bits 2 and 3 are no longer used for the remaining comparison.
- The ABS/EDL control unit transmits a bit with priority.
- The Motronic control unit likewise transmits a bit with priority.

**Bit 2 in the arbitration field**

- The ABS/EDL control unit transmits a bit with priority.
- The Motronic control unit transmits a bit without priority and detects a bit with priority on the databus line. It consequently loses its assignment and becomes a receiver. Bit 3 is thus no longer used for the further comparison.

**Bit 3 in the arbitration field**

- The ABS/EDL control unit has the highest priority and thus acquires the assignment. It continues transmitting its data protocol to the end.
- After the ABS/EDL control unit has completed transmission of its data protocol, the others once again try to transmit their protocol.

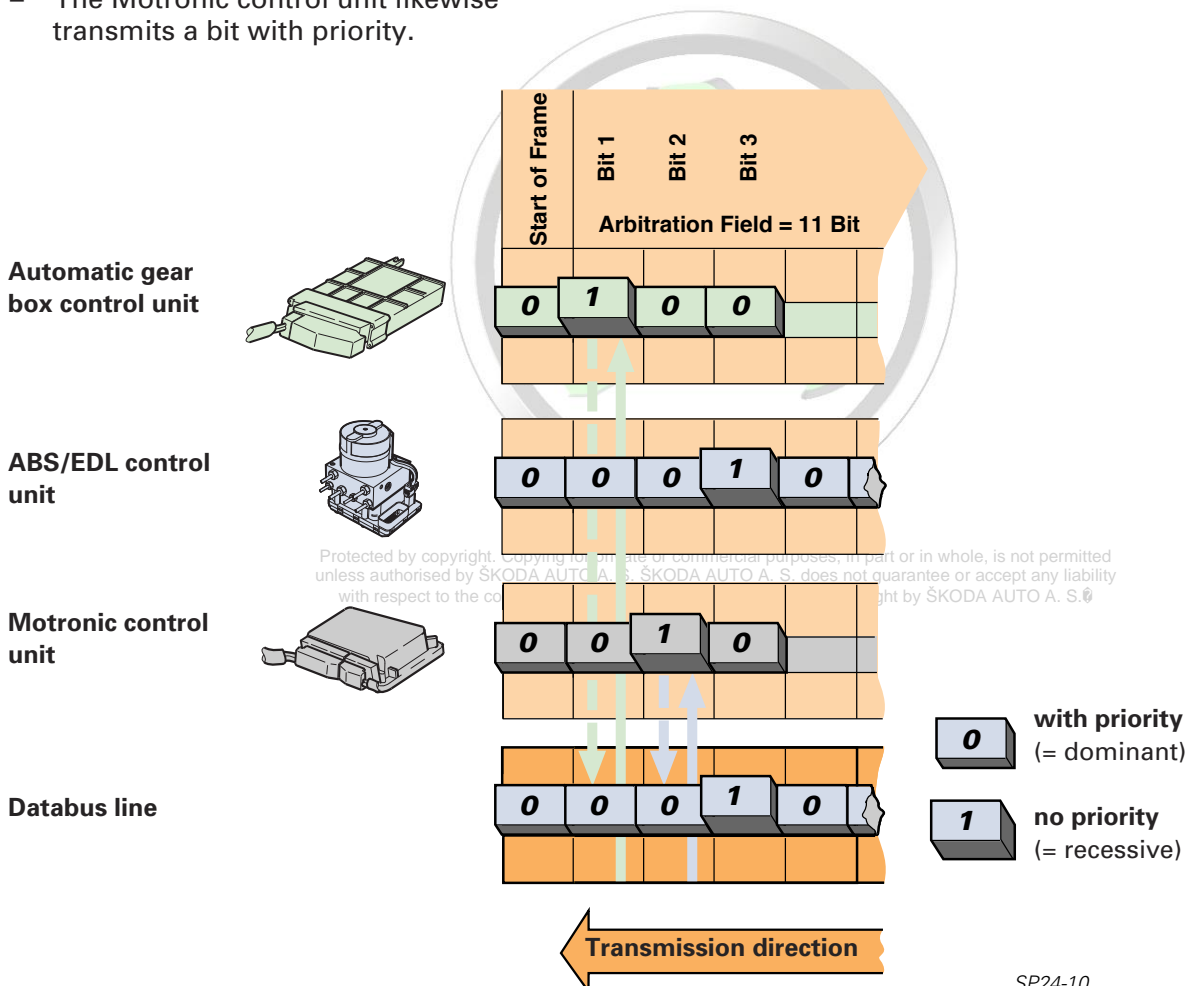

SP24-10

# Function

## The sources of interference

In a vehicle, components which produce sparks when operating or power circuits which are open or closed, are sources of interference.

Other sources of interference, for example, are mobile phones and radio stations, in other words everything which produces electromagnetic waves.

The interference field of such sources can detrimentally affect or falsify data transmission.

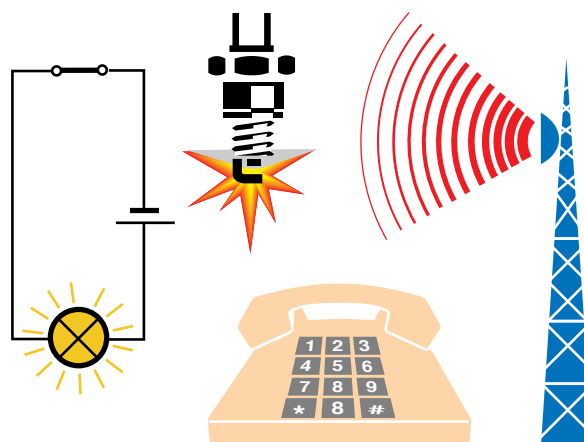

SP24-11

The two unscreened databus lines are twisted together in order to prevent sources of interference affecting data transmission.

A differential signal is transmitted along with twisted wires, in other words the respective voltages are opposed on the wires.

If a voltage of approx. 0 V exists on the one databus wire, the voltage which exists on the other wire is approx. 5 V.

In the reversed situation, both wires have a voltage which is identical, approximately average of 2.5 V.

Consequently, the voltage sum is constant at any time and the electromagnetic field effects of the two databus lines cancel each other out.

The databus line is protected in this way against external interference waves and is practically neutral to the outside.

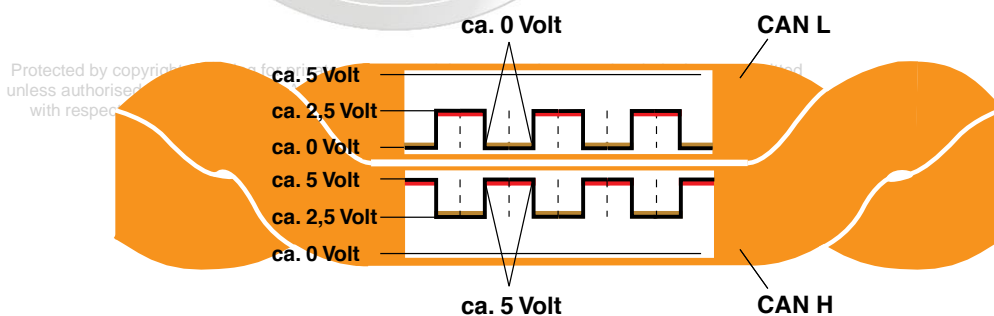

SP24-27

# Drive CAN databus

## The drive databus system

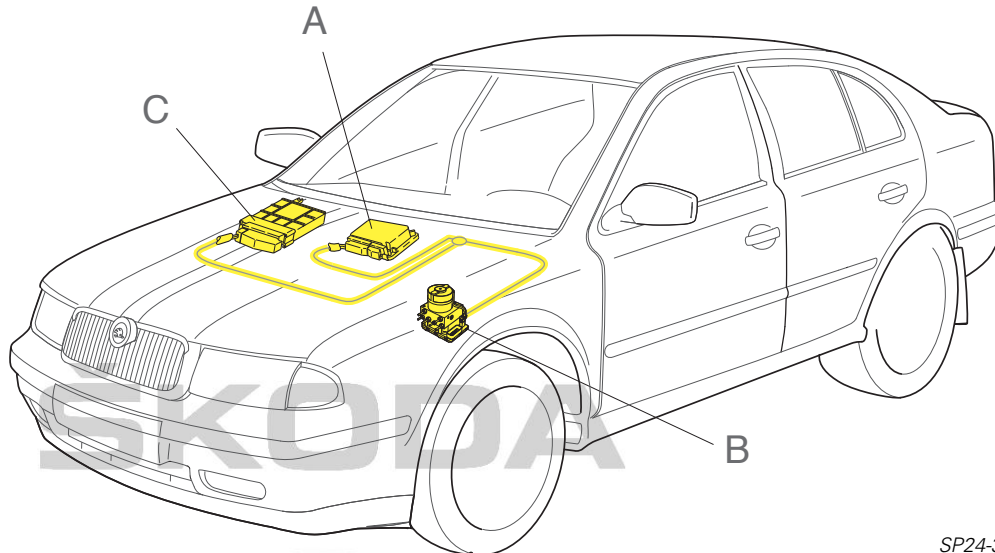

SP24-3

The control units in the drive databus system

- A = Motronic control unit J220
- B = ABS/EDL control unit J104
- C = Automatic gear box control unit J217

The databus links the 3 control units

- for Motronic
- for ABS/EDL
- for automatic gear box

The particular advantage which the CAN databus offers in the power train sector is its high transmission rate.

At present four data protocols are transmitted between the control unit:

two by the Motronic control unit,  
one by the ABS/EDL control unit,  
one by the automatic gear box control unit.



### Note:

**When fault finding, first of all use the current flow diagram to determine whether and how many control units communicate with each other through the bus, e.g. the 1.6 ltr 55 kW engine is not integrated in the drive CAN bus.**

The CAN wires are merged in a star shape in a connector. An insulating sheath protects them from external damage.

The node of the databus is located outside of the control units.

**Then, make the following distinction:**

- **two control units communicate over a "two-wire bus system",**
- **three or more control units communicate over a "two-wire bus system".**



# Drive CAN databus

## Features of the drive CAN databus

- The databus as a transmission medium consists of two wires over which the information is transmitted.



SP24-25

- The two databus wires are twisted together in order to minimize electromagnetic interference fields and external interference waves.



SP24-26

- The drive databus operates at a rate of 500 kbit/s (500,000 bits per second). Consequently, it is within the high speed range of 125 - 1,000 kbit/s. The transfer of the data protocol takes approximately 0.25 milliseconds. In contrast, the convenience electronics databus operates at 62.5 kbit/s. The two databuses are not interlinked.



SSP186/23

- Depending on the control unit, an attempt is made to transmit data at intervals of 7 - 20 milliseconds.

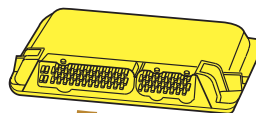

SP24-18

- Priority sequence:
  1. ABS/EDL control unit →
  2. Motronic control unit →
  3. Automatic gear box control unit

The priority is the result of the evaluation of safety and time criteria. Consequently, active accident avoidance has priority stage 1.

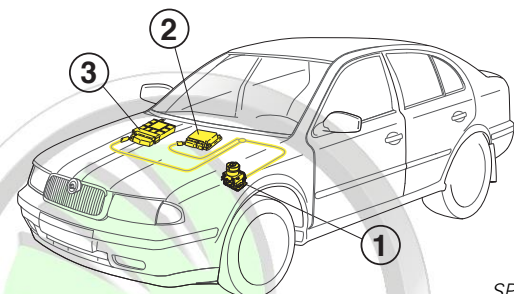

SP24-16

In the drive sector, it is necessary to transmit the data very rapidly to enable them to be used to the most effective extent. This, in turn, necessitates an extremely powerful transceiver.

This transceiver makes it possible to transfer data between two ignitions. Consequently, the data received can already be used for the next ignition pulse.

## Information in the drive sector

### Which information is transmitted?

These are items of information which are extremely important for the tasks performed by the individual control units. Safety tasks in the case of the ABS/EDL control unit, control of fuel injection and ignition in the case of the engine control unit as well as the demands of ride

comfort when it comes to the automatic gear box control unit form the starting point for the information.

The table below shows part of the data field of the respective data protocols, by way of example.

Priority	Data protocol of	Information
1	ABS/EDL control unit	<ul style="list-style-type: none"> <li>- Overrun torque control (OTC) request</li> <li>- Traction control system (TCS) request</li> </ul>
2	Engine control unit, data protocol 1	<ul style="list-style-type: none"> <li>- Engine speed</li> <li>- Throttle valve position</li> <li>- Kickdown</li> </ul>
3	Engine control unit, data protocol 2	<ul style="list-style-type: none"> <li>- Coolant temperature</li> <li>- Vehicle speed</li> </ul>
4	Automatic gear box control unit	<ul style="list-style-type: none"> <li>- Gear change</li> <li>- Gear box in emergency running mode</li> <li>- Selector lever position</li> </ul>

The table below shows the structure of an individual item of information, taking the example of the throttle valve opening angle

Only a part of the complete information is shown because of the high number of possible items of information.

The momentary position of the throttle valve is transmitted with 8 bits.

This, in turn, results in 256 different versions of the composition of the bits.

It is possible to transmit throttle valve positions ranging 0° up to 102° in spacings of 0.4.

Bit string	Throttle valve position
0000 0000	000,0° Throttle valve opening angle
0000 0001	000,4° Throttle valve opening angle
0000 0010	000,8° Throttle valve opening angle
.....	.....
0101 0101	034,0° Throttle valve opening angle
.....	.....
1111 1111	102,0° Throttle valve opening angle

# Drive CAN databus

## Networking of the components in the drive databus



The drive databus comprises:

- J104 ABS/EDL control unit
- J217 Automatic gear box control unit
- J220 Motronic control unit

The control units are interlinked in a star shaped by the twisted CAN bus.

The star architecture offers the following advantages compared to other types of networking:

- only partial failure in the event of network fault
- system function retained even if number of users reduced (e.g. if a manual gear box is used in place of the automatic gear box)
- low failure probability

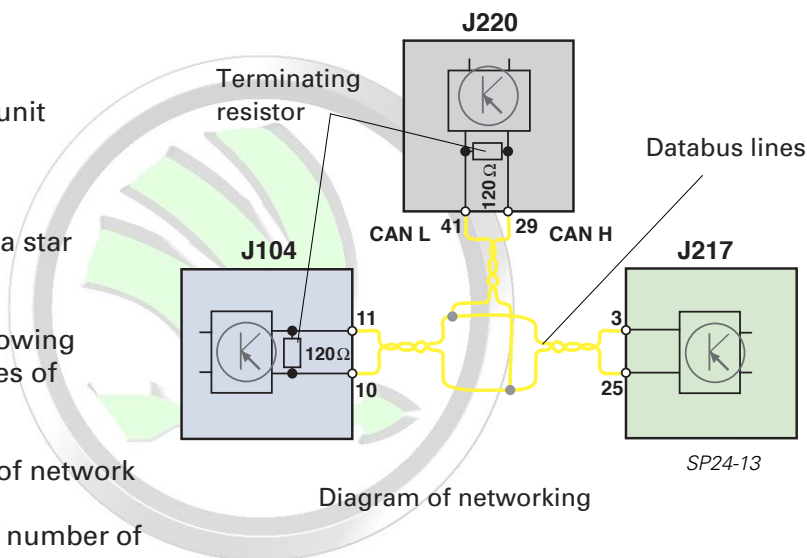

Reproduction for private or commercial purposes, in part or in whole, is not permitted unless authorised by ŠKODA AUTO A. S. ŠKODA AUTO A. S. does not guarantee or accept any liability with respect to the correctness of information in this document. Copyright by ŠKODA AUTO A. S. ©

If the control units are merged in a star shape, only one component, namely the star point (or node), causes a system failure.

The databus lines are integrated in the vehicle wiring harness.

The node is located in the protective housing for the plug connections in the left of the plenum chamber, in other words outside of the control unit.

The two resistors for the databus terminal are located one in the Motronic control unit and one in the ABS/EDL control unit.

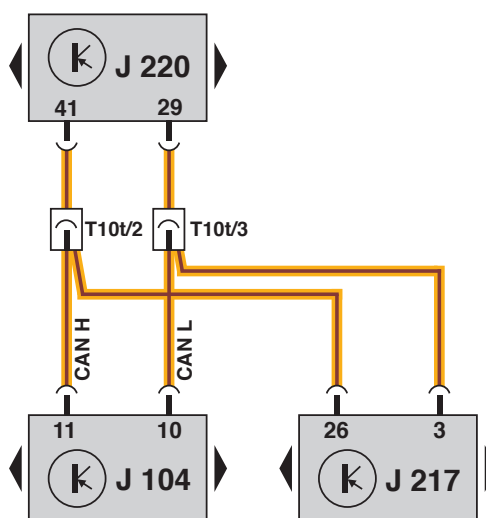

SP24-14

Function diagram based on current flow diagram

## Self diagnosis Drive CAN databus

Self diagnosis for the drive CAN databus can be carried out using the vehicle system tester V.A.G. 1552 or the fault reader V.A.G. 1551.

### Address words:

- 01 for engine electronics
- 02 for gear box electronics
- 03 for ABS electronics



### Note:

All the control units which exchange information with each other, have to be regarded as a complete system in terms of self diagnosis and when it comes to fault finding.

After completing repairs, the fault memories of all the control units should be read in order to find any faults which may be stored.

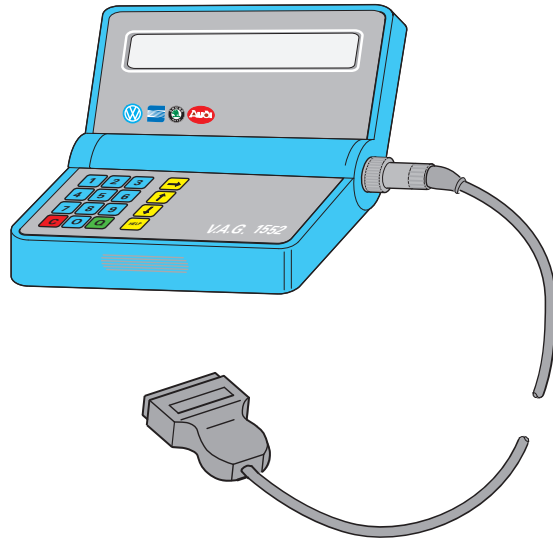

SP17-29

The following function relates to the CAN databus:

### Function 02 - Interrogating fault memory

- A fault is stored in the control units if the following problems occur on the databus:
- one or more databus lines has an open circuit.
- databus lines have a short circuit to each other.
- one databus line has a short circuit to earth and positive.
- one or more control units are faulty
- transmission fault/implausible signal.

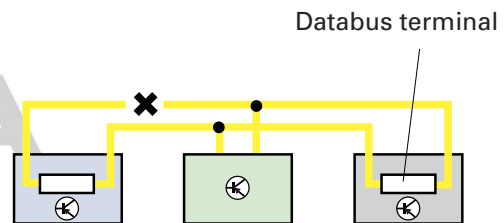

SP24-22

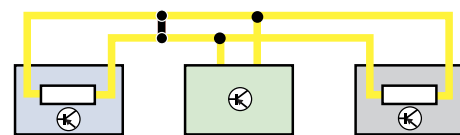

SP24-23

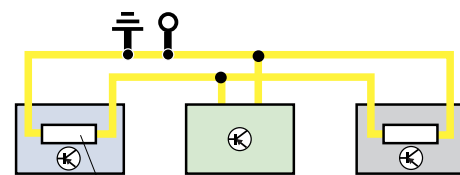

SP24-24

Databus terminal

# Convenience electronics CAN databus

## The convenience electronics databus system

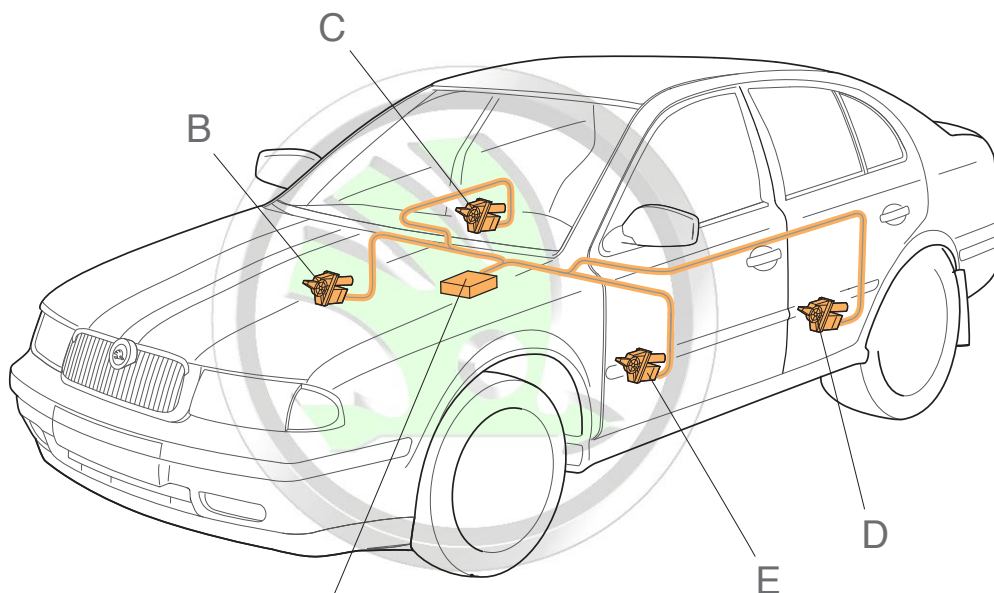

Protected by copyright. Copying for private or commercial purposes, in part or in whole, is not permitted unless authorised by ŠKODA AUTO A. S. ŠKODA AUTO A. S. does not guarantee or accept any liability with respect to the correctness of information in this document. Copyright by ŠKODA AUTO A. S. SP24-4

The control units in the convenience electronics databus system

- A = convenience system central control unit J393
- B = passenger-side door control unit J387
- C = rear right door control unit J389
- D = rear left door control unit J388
- E = driver-side door control unit J386

The databus system of the convenience electronics includes the central control units and four door control units.

Each door control unit operates functionally independent (local control). The central control unit does not have a master function.

The control units of the 4 doors and the central control unit are interlinked by the two CAN lines (CAN H and CAN L).

At the same time, the central control unit is the transit point to the diagnostic interface of the vehicle.

Diagnosis is carried out at the K wire connection at the central control unit.

Information regarding functions in the doors (switch signals, closing states) are transmitted along with CAN wires to the other users.

Information from the vehicle (e.g. ignition terminal 15, rear window heater, road speed) is output by the central control unit as part of data transfer.

## Features of the CAN databus in the convenience system

- The databus consists of two wires along which the information is transmitted.



SSP186/22

- The two databus wires are twisted together in order to minimize electromagnetic interference fields and external interference waves.



SSP186/24

- The convenience system databus operates at the rate of 62.5 kbit/s (62,500 bits per second). It is within the low speed range of 0 - 125 kbit/s. The transmission of the data protocol takes approximately 1 millisecond. (In contrast, the drive databus operates at 500 kbit/s).



SSP186/23

- Each control unit attempts to transmit its data at intervals of 20 milliseconds.

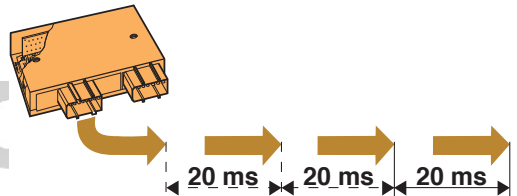

SP24-19

- Priority:
  1. central control unit
  2. driver-side door control unit
  3. passenger-side door control unit
  4. rear left door control unit
  5. rear right door control unit

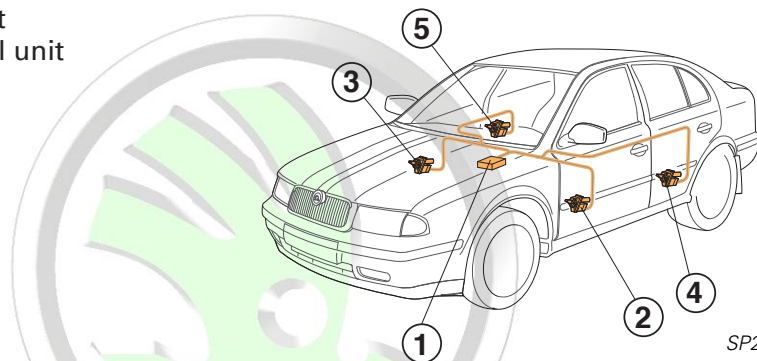

SP24-17

It is possible to use a transceiver with only a low performance because the data in the convenience system can be transmitted at a relatively low rate.

The data can continue to be transmitted.

You can find more detailed information on the convenience electronics system of the OCTAVIA in Self-study Program 17.

This offers the advantage of being able to switch over to the single-wire mode in the event of a failure of a databus line.

Protected by copyright. Copying for private or commercial purposes, in part or in whole, is not permitted without the prior written consent of ŠKODA AUTO A. S. ŠKODA AUTO A. S. does not guarantee or accept any liability for the accuracy or completeness of information in this document. Copyright by ŠKODA AUTO A. S. ©

# Test your knowledge

# SKODA

Which answers are correct?  
Sometimes only one.  
Perhaps also more than one - or all!



1. In the OCTAVIA, the CAN databus is presently used in the:

- A. drive sector
- B. convenience sector
- C. information sector

Protected by copyright law  
unless authorised in writing  
with respect to

For any other purposes, in part or in whole, is not permitted  
ŠKODA AUTO A. S. does not guarantee or accept any liability  
for the content of this document. Copyright by ŠKODA AUTO A. S. ©

2. The advantages of the CAN databus are:

- A. fewer sensors and signal wires
- B. gain in space
- C. very rapid data transfer
- D. low susceptibility to faults

3. The CAN databus possesses:

- A. one databus line
- B. two databus lines
- C. two twisted databus lines

4. The following are transmitted over the CAN databus:

- A. data protocols
- B. information
- C. bits

5. The CAN databus:

- A. has a self diagnosis capability
- B. does not have a self diagnosis capability

6. The following communicate in the drive databus:
- A. the control units of the convenience electronics with the ABS control unit
  - B. the gear box control unit and the ABS control unit
  - C. the control unit for Motronic, for automatic gear box and for ABS/EDL
7. Interference fields are minimized in the CAN databus by:
- A. Sheathing both CAN wires with a screening
  - B. twisting the two CAN wires
  - C. using coaxial cables
8. A bit can either have the logical state 0 or 1. One of these has priority.
- A. a bit with 0 volts has the state 1 and priority.
  - B. a bit with 5 volts has the state 1 and priority.
  - C. a bit with 0 volts has the state 0 and priority.
9. The logical state of a bit plays a decisive role:
- A. for the address words in self diagnosis
  - B. for defining priority in the arbitration field of a data protocol
  - C. when it comes of the structure of the data protocol
10. The node of the drive databus in the SKODA OCTAVIA is located
- A. in the Motronic engine control unit
  - B. in the protective housing for the plug connections of the wiring harness in the plenum chamber
  - C. in the K wire of the diagnostic connection
11. In the SKODA OCTAVIA, not all engine versions are linked through the databus to other control units. In some cases, there are still also individual wires. When carrying out service work, this is
- A. displayed by the fault reader
  - B. defined by referring to the current flow diagram

1. A., B.; 2. A., B.; 3. C.; 4. A., B., C.; 5. A.; 6. C.; 7. B.; 8. C.; 9. B.; 10. B.; 11. B.

Answer



# CAN bus dictionary

A number of new technical expressions appear in connection with the CAN bus in the SKODA OCTAVIA. These are briefly explained below.

**Bit** = binary digit, smallest unit of information

**BUS** = **Bitserial Universal Interface**, a system for transporting and distributing data

**Bus system** = individual control units, databus

**Byte** = addressable unit of information of 8 successive bits

**CAN** = **Controller Area Network**, a serial bus system designed specifically for use in vehicles; operates with two wires

**CAN bus** = several control units of equal priority are interlinked by a linear bus structure.

**Advantage:** If one user fails, the bus structure remains fully available for all the other users.

**CAN controller** = reads data which are to be transmitted along the bus line or which are received along this line

**CAN transceiver** = transmitter and receiver of electric signals, combination of **Transmitter + Receiver**

**Data Frame** = data frame of the data protocol

**Data protocol** = message which is transmitted; made up of standardized structure of seven fields

**Priority** = sequence of the message to be transmitted as a function of the evaluation of safety and time criteria

**Serial** = arrange one after the other in series

**Interference field** = **electromagnetic waves, generated by external components, which adversely affect or falsify data transfer**

Protected by copyright. Copying for private or commercial purposes, in part or in whole, is not permitted unless authorised by ŠKODA AUTO A. S. ŠKODA AUTO A. S. does not accept any responsibility with respect to the correctness of information in this document. Copyright by ŠKODA AUTO A. S.